



# Cenník komerčného chladenia 2019

- RIEŠENIE PRE CHLADENIE -



## Tabuľka pojmov a vysvetliviek

<b>ODS</b>	Outside Diameter Solder	Vonkajší rozmer pájkovací
<b>ODF</b>	Outside Diameter Flare	Vonkajší rozmer závit (pertel)
<b>SAE</b>	Society of Automobile Engineers	Asociácia automobilových inžinierov - organizácia zastrešujúca mnoho priemyselných štandardov
<b>BO</b>	Burn Out	Po vyhorení - najčastejšie používaný termín pre sacie filterdehydrátory
<b>NPT</b>	National pipe thread	Národný závit potrubí - Americký štandard závitov pre potrubia
<b>DN, Ø</b>	Diametre Nominal	Nominálny priemer - Európsky štandard priemeru, najmä potrubí
<b>Δ</b>	delta	Rozdiel, údaj používaný najmä pre rozdiely teplôt a tlakov
<b>BTU</b>	British thermal unit	Jednotka energie, cca 1055 joulov, alebo cca 0,293 Watthodín
<b>POE</b>	Polyol Ester	Polyol esterový olej, syntetický olej hlavne pre nové chladivá

Prevod dĺžkových mier		Prevod energetických mier		Prevod tepelných mier	
"	mm	BTU	Watt/h	°C	°F
1/4	6,350	7 000	2 051	-30	-22
3/8	9,525	9 000	2 638	-17,7	0
1/2	12,700	12 000	3 517	-10	14
5/8	15,875	18 000	5 275	-5	23
3/4	19,050	24 000	7 034	0	32
7/8	22,225	36 000	10 551	5	41
1	25,400	42 000	12 309	7,2	45
1-1/8	28,575	48 000	14 067	10	50
1-1/4	31,750	56 000	16 412	15	59
1-3/8	34,925	60 000	17 584	20	68
1-1/2	38,100	65 000	19 050	25	77
1-5/8	41,275	70 000	20 515	30	86
1-3/4	44,450	75 000	21 980	35	95
1-7/8	47,625	80 000	23 446	43,33	110
2	50,800	85 000	24 911	50	122
2-1/8	53,975	90 000	26 376	54,44	130
2-1/2	63,500	95 000	27 842	100	212
3	76,200	100 000	29 307	1000	1 832

Cenník je určený pre veľkoobchodných zákazníkov firmy DTN, s.r.o.. Ceny uvedené sú platné do 1.4. 2017 a spoločnosť DTN s.r.o. si vyhradzuje právo na zmenu cien bez upozornenia. Na produkty, kde nie je uvedená cena je nutné si pýtať individuálnu cenovú ponuku od obchodných zástupcov firmy DTN, s.r.o.. Obrázky pri produktoch sú ilustračné a nemusia zodpovedať reálnym produktom.

<b>1. Kompresory</b>	<b>5</b>
Embraco - hermetické kompresory	6
Tecumseh L'Unite - hermetické kompresory	10
Danfoss - hermetické kompresory	13
Danfoss - Maneurop hermetické kompresory, Performer scroll kompresory	14
Copeland - scroll kompresory	15
Copeland - DWM polohermetické kompresory	19
Bitzer - polohermetické kompresory	20
Dorin - polohermetické kompresory	22
Klimatizačné kompresory	24
<b>2. Agregáty</b>	<b>27</b>
Copeland	28
Dorin	29
Embraco	31
Tecumseh L'Unite	33
Embraco BIOMA	34
Refra	36
<b>3. Výparníky a príslušenstvo</b>	<b>37</b>
Roen Est	38
Wind ventiláry a príslušenstvo	41
<b>4. Komponenty chladiacích okruhov</b>	<b>45</b>
FrigoMEC príslušenstvo, matice, spojky	46
Plniace ventily, kapiláry	47
<b>5. Chladiarenská automatizácia</b>	<b>49</b>
Sanhua RFKH	50
Danfoss ventily T2/TE2, TE5-TE55, TUA/TUAE	52
Alco ventily TIS-TISE, T	53
Honeywell	54
Filterdehydrátory	56
Priehľadítka	59
Magnetické ventily	60
Guľové ventily	61
Presostaty Danfoss, Ranco	63
Mini presostaty, rohové ventily, trojcestné ventily	64
<b>6. Elektronické komponenty</b>	<b>65</b>
Eliwell	66
Pego	67
Ohrevy, Univerzálne riadenia klimatizácií	68
Elektroinštalačný materiál a príslušenstvo	69
Kondenzátory, elektroinštalačné náradie	70
<b>7. Náradie</b>	<b>71</b>
Vákuovačky, odsávačky, váhy	72
Spájkovacie sety, detektory	73
Meracie náradie, náradie pre potrubia	74
Manometre	77
Doplňky	79
<b>8. Chladiace boxy</b>	<b>81</b>
Chladiace dvere otočné, posuvné	82
Chladiace panely a príslušenstvo	83
<b>9. Medené potrubie, izolácie, tvarovky</b>	<b>87</b>
Medené potrubie	88
Medené tvarovky	90
Kaučukové izolácie, príslušenstvo	92
Konzoly, podložky	94
Čerpadlá kondenzu a príslušenstvo	95
PVC žľaby a tvarovky	98
<b>10. Chladivá, mazivá, nemrznúce zmesi, čistiace prostriedky</b>	<b>101</b>
Chladivá	102
Mazivá	103
Čistiace prostriedky	104
Nemrznúce zmesi, testery	105



# Kompresory



KOMPRESORY



MODEL	Objem valca cm <sup>3</sup>	Meraný bod		Kond. teplota °C	Chladiaci výkon °C						Max. výška mm	Cena bez DPH
		-23,3 °C / 54,4 °C			W							
		Výkon			-30	-25	-20	-15	-10	-5		
EMY3109Z	4,0	105	55	-	-	-	-	-	-	-	166	
			45	-	-	-	-	-	-	-		
EMY3111Z	4,5	129	55	81	113	153	202	260	325	171		
			45	90	123	165	216	275	343			
EMY3115Z	6,1	163 / 171	55	-	-	-	-	-	-	171		
			45	-	-	-	-	-	-			
NEK2116Z	7,4	187	55	-	136	184	241	305	378	187	100,76	
			45	121	166	221	284	357	436			
NE2121Z	9,3	253	55	-	186	246	319	403	500	206	117,35	
			45	166	220	288	370	464	572			
NE2130Z	12,1	343	55	-	255	332	426	536	660	200	125,96	
			45	227	298	386	491	613	753			
NE2134Z	14,3	359	55	-	267	351	453	571	711	206	129,31	
			45	234	313	410	526	662	822			
NEK2140Z	16,8	429	55	-	319	421	543	686	820	206	142,51	
			45	274	372	493	635	799	991			

R404A/R507/R452A - LBP

MODEL	Objem valca cm <sup>3</sup>	Meraný bod		Kond. teplota °C	Chladiaci výkon pri odparovacej teplote °C						Max výška mm	Cena bez DPH
		-23,3 °C / 54,4 °C			W							
		Výkon			-40	-35	-30	-25	-20	-15		
NEK2117GK	4,5	235	55	-	-	117	154	197	247	303	188	
			45	80	111	149	194	246	306	374		
EMT2117GK	4,5	244	55	-	-	127	166	211	264	326	166	97,52
			45	91	125	164	210	265	330	408		
EMT2121GK	5,2	300	55	-	-	168	212	264	327	400	166	101,01
			45	120	159	204	258	322	398	487		
NEK2121GK	5,4	282	55	-	-	143	188	241	303	375	188	115,65
			45	104	139	184	238	302	377	463		
EMT2125GK	6,0	351	55	-	-	190	242	303	375	458	166	110,33
			45	140	185	238	301	373	462	562		
NEK2125GK	6,2	341	55	-	-	168	221	283	354	433	188	118,29
			45	120	160	214	278	353	439	533		
EMT2130GK	6,8	390	55	-	-	205	263	330	407	497	171	112,68
			45	150	200	257	326	406	500	605		
NEK2130GK	7,4	399	55	-	-	202	267	341	425	521	200	123,35
			45	131	188	255	332	421	523	639		
NEK2134GK	8,8	452	55	-	-	236	309	394	491	600	206	125,19
			45	169	225	297	332	487	606	741		
NEU2140GK	8,8	486	55	-	-	260	339	432	536	654	200	
			45	183	246	326	421	531	658	801		
NEK2150GK	12,1	604	55	-	-	299	395	509	640	788	206	137,80
			45	212	286	381	429	634	791	969		
NEU2155GK	12,1	658	55	-	-	413	477	546	713	870	206	136,20
			45	246	328	432	557	705	875	1067		
NEU2168GK	14,3	744	55	-	-	298	522	661	814	982	206	155,36
			45	271	372	496	642	810	1000	1213		
NT2168GK	14,5	642	55	-	-	319	422	542	685	859	220	207,00
			45	206	310	423	549	698	875	1089		
NEK2172GK	16,8	824	55	-	-	439	570	722	895	1090	206	176,91
			45	312	420	553	711	894	1103	1336		
NEU2178GK	16,8	914	55	-	-	468	605	765	947	1152	206	181,18
			45	334	447	586	753	947	1168	1416		
NT2178GK	17,4	812	55	-	-	392	520	674	854	1063	220	230,57
			45	292	394	525	685	878	1105	1372		
NT2180GK	20,4	935	55	-	-	483	640	814	1007	1224	234	241,55
			45	332	468	625	814	1034	1286	1573		
NT2192GK	22,4	1089	55	-	-	522	681	867	1083	1330	234	249,75
			45	367	505	672	869	1100	1366	1669		
NT2192GS	22,4	1049	55	-	-	516	675	860	1072	1315	250	
			45	364	504	673	872	1106	1378	1690		
NT2210GK	26,2	1306	55	-	-	640	839	1069	1331	1624	234	271,04
			45	431	597	804	1052	1340	1670	2041		
NT2212GK	27,8	1373	55	-	-	688	888	1127	1405	1728	250	258,85
			45	503	671	876	1125	1421	1770	2174		
NJ2212GS	34,4	1481	55	-	-	660	919	1220	1565	1953	277	308,04
			45	506	697	946	1256	1626	2055	2544		
NjX2219GS*	38,0	2164	55	-	-	1052	1374	1749	2177	2658	277	
			45	775	1025	1343	1731	2186	2710	3303		

# embraco

## EMBRACO Kompresory

R600a



MODEL	Objem valca cm <sup>3</sup>	Meraný bod		Kon- den- začná teplota °C	Chladiaci výkon pri odparovacej teplote °C						Max výška mm	Cena bez DPH
		-23,3 °C / 54,4 °C			W							
		Výkon W										
EMX20CLC	4,0	63	55	36	49	64	82	102	126	166	na dopyt	
			45	44	58	76	96	119	146			
EMX26CLC	5,2	81	55	43	59	80	104	133	165	166	na dopyt	
			45	53	72	96	124	156	192			
EMX32CLC	6,0	92	55	49	69	92	119	151	189	166	na dopyt	
			45	64	86	111	141	176	218			
EMX3109Y	6,2	100	55	-	-	-	-	-	-	171	na dopyt	
			45	-	-	-	-	-	-			
EMC40CLT	7,2	117	55	78	107	142	187	233	260	171	na dopyt	
			45	88	118	154	198	248	300			
EMC46CLT	8,0	133	55	88	119	158	203	256	280	166	na dopyt	
			45	95	129	169	215	269	310			
EMX3113Y	9,0	155	55	-	-	-	-	-	-	171	na dopyt	
			45	-	-	-	-	-	-			
EMX55CLC	9,0	156	55	87	117	154	197	245	303	166	108,24	
			45	102	135	175	222	277	339			
EMX3115Y	10,6	184	55	-	-	-	-	-	-	166	na dopyt	
			45	-	-	-	-	-	-			
EMX66CLC	10,6	183	55	101	137	178	227	284	348	166	na dopyt	
			45	122	160	207	261	323	394			
EMX70CLC	11,1	191	55	103	143	184	233	290	360	166	114,60	
			45	123	164	210	263	327	403			
EMX3118Y	12,2	212	55	-	-	-	-	-	-	166	na dopyt	
			45	-	-	-	-	-	-			
EMY3118Y	12,2	212	55	-	-	-	-	-	-	171	na dopyt	
			45	-	-	-	-	-	-			
EMY3118Y	12,2	213	55	-	-	-	-	-	-	171	na dopyt	
			45	-	-	-	-	-	-			
EMX3118Y	12,2	214	55	-	-	-	-	-	-	171	na dopyt	
			45	-	-	-	-	-	-			
EMX80CLT	12,2	213	55	118	162	207	265	331	406	171	121,55	
			45	139	185	240	305	380	464			
NBY1118Y	14,3	244	55	138	183	234	299	375	464	195	106,04	
			45	159	206	266	339	427	529			

EMBRACO

embraco

EMBRACO Kompresory MBP

R404A - R507 MBP



EMBRACO

MODEL	Objem valca cm <sup>3</sup>	Meraný bod		Kond. teplota °C	Chladiaci výkon pri odparovacej teplote °C						Max výška mm	Cena bez DPH
		-10 °C / 45 °C			W							
		Výkon W			-20	-15	-10	-5	0	5		
EMT6144GK	4,0	378	55	-	-	303	370	448	535	634	166	94,90
			45	246	307	377	458	551	656	773		
EMT6152GK	4,5	424	55	-	-	339	413	497	593	699	166	98,39
			45	275	344	422	511	614	731	861		
EMT6165GK	5,2	484	55	-	-	384	471	570	682	808	166	101,84
			45	315	392	482	586	706	840	989		
NEK6165GK	6,2	542	55	-	-	443	533	639	759	895	187	112,88
			45	388	454	542	650	781	931	1103		
NEK6181GK	7,3	599	55	-	-	483	587	711	853	1013	187	117,42
			45	405	491	599	730	882	1057	1252		
NEU6210GK	7,3	645	55	-	-	521	642	780	933	1103	200	
			45	408	517	645	791	956	1139	1341		
NEK6210GK	8,8	724	55	-	-	571	698	849	1021	1216	200	126,16
			45	500	598	724	877	1058	1265	1499		
NEK6210GK	8,8	733	55	-	-	586	723	879	1054	1247	200	121,88
			45	468	589	733	900	1091	1305	1540		
NEU6212GK	8,8	792	55	-	-	643	788	952	1134	1336	200	125,06
			45	505	638	793	970	1169	1390	1632		
NEK6213GK	12,1	972	55	-	-	788	958	1150	1366	1603	206	138,73
			45	666	804	972	1171	1403	1666	1963		
NEU6215GK	12,1	1267	55	-	-	904	1098	1318	1566	1840	206	156,43
			45	728	903	1108	1342	1605	1898	2221		
NT6217GK	12,6	915	55	-	-	699	870	1068	1294	1548	220	201,66
			45	585	732	915	1132	1384	1672	1994		
NEK6217GK	14,3	1166	55	-	-	955	1157	1386	1638	1916	206	176,62
			45	777	954	1166	1411	1690	2003	2347		
NT6222GK	17,4	1332	55	-	-	1038	1276	1551	1866	2226	220	235,11
			45	846	1071	1332	1635	1981	2372	2811		
NT6224GK	20,4	1573	55	-	-	1244	1540	1879	2258	2678	220	242,58
			45	996	1261	1573	1933	2339	2787	3278		
NJ9226GK	21,7	1648	55	-	-	1255	1581	1944	2340	2766	265	270,26
			45	982	1285	1648	2066	2536	3055	3618		
NJ9226GS	21,7	1667	55	-	-	1278	1609	1980	2389	2838	265	281,77
			45	989	1301	1667	2086	2560	3087	3668		
NT6226GK	22,4	1752	55	-	-	1412	1724	2091	2518	3014	234	248,34
			45	1137	1420	1753	2143	2597	3122	3724		
NJ9232GK	26,1	1911	55	-	-	1414	1817	2271	2771	3315	277	275,79
			45	1093	1470	1911	2413	2973	3588	4255		
NJ9232GS	26,1	1972	55	-	-	1513	1911	2357	2853	3396	277	297,66
			45	1166	1535	1972	2476	3047	3684	4388		
NTU6238GKV	26,2	2288	55	-	-	1826	2233	2691	3186	3706	253	
			45	1523	1854	2282	2794	3376	4016	4700		
NTU6240GKV	27,8	2431	55	-	-	1940	2358	2837	3372	3959	253	
			45	1622	1978	2425	2957	3570	4258	5017		
NJ9238GK	32,7	2424	55	-	-	1895	2323	2804	3347	3958	277	286,01
			45	1507	1939	2424	2970	3583	4272	5044		
NJ9238GS	32,7	2506	55	-	-	1883	2345	2863	3435	4062	277	293,92
			45	1514	1979	2506	3091	3735	4441	5207		
NJX6250GS*	38,0	3245	55	-	-	2589	3141	3766	4464	5235	277	
			45	2120	2648	3253	3935	4694	5530	6443		



embraco

EMBRACO Kompresory HBP

R134a HBP



EMBRACO

MODEL	Objem valca cm <sup>3</sup>	Meraný bod		Kond. teplota °C	Chladiaci výkon °C					Max. výška mm	Cena bez DPH
		5 °C / 50 °C			W						
		Výkon W			-15	-10	-5	0	5		
EMT37HDP	3,4	321	55	-	153	194	241	294	355	158	86,49
			45	142	181	228	245	343	412		
EMT45HDR	4,0	379	55	-	150	189	237	298	361	166	92,18
			45	146	184	229	284	402	423		
EMT50HDP	4,5	423	55	-	203	256	318	388	472	166	96,32
			45	191	242	303	374	456	549		
EMT6144Z	5,2	519	55	-	250	313	388	474	573	166	98,81
			45	232	294	367	395	549	661		
EMT6160Z	6,8	648	55	-	322	403	495	600	718	166	102,27
			45	298	377	469	504	696	830		
NEK6160Z	7,3	663	55	-	296	376	472	586	716	187	110,15
			45	281	355	448	481	687	834		
EMT6170Z	7,7	725	55	-	358	448	550	663	789	166	104,28
			45	330	418	522	559	771	915		
NEK6170Z	8,4	775	55	-	358	451	563	693	841	200	115,26
			45	335	420	526	573	802	971		
NEK6170Z	8,4	762	55	-	313	384	496	650	844	187	115,26
			45	337	367	445	505	742	958		
NEK6187Z	10,0	896	55	-	402	511	642	793	965	200	121,20
			45	378	477	600	654	918	1113		
NEK6210Z	12,1	1046	55	-	480	619	773	942	1127	200	127,82
			45	456	578	726	787	1097	1319		
NEU6210Z	12,1	1109	55	-	530	672	839	1032	1250	200	126,40
			45	483	618	780	969	1186	1431		
NEU6212Z	14,3	1271	55	-	595	767	965	1188	1437	200	131,63
			45	556	706	892	1111	1365	1653		
NEK6214Z	16,8	1315	55	-	640	814	1008	1215	1473	206	159,72
			45	593	752	945	1026	1412	1701		
NEU6214Z	16,8	1492	55	-	-	927	1150	1407	1699	206	168,60
			45	663	844	1063	1320	1615	1946		
NT6215Z	17,4	1435	55	-	646	843	1071	1326	1606	207	195,55
			45	621	796	1014	1090	1567	1894		
NT6217Z	20,4	1680	55	-	772	980	1232	1532	1890	220	206,90
			45	712	921	1171	1471	1827	2250		
NT6220Z	22,4	1752	55	-	861	1081	1342	1649	2011	220	215,42
			45	808	1021	1285	1601	1973	2409		
NJ6220Z	26,1	2071	55	-	876	1147	1456	1821	2259	265	256,33
			45	830	1114	1425	1781	2199	2696		
NJ6220ZX	26,1	2240	55	-	993	1326	1693	2096	2534	265	270,41
			45	882	1159	1502	1723	2389	2932		
NJ6226Z	34,4	2610	55	-	1182	1531	1923	2371	2886	253	269,60
			45	1144	1497	1892	2340	2852	3438		
NJ6226ZX	34,4	2740	55	-	1214	1589	2004	2457	2950	265	286,60
			45	1304	1644	2044	2039	3027	3608		



Kompresory Tecumseh

R134a MBP/HBP



TECUMSEH

Typ	Objem valca cm <sup>3</sup>	Výkon pri odparovacej teplote Q [W]							Cena bez DPH Eur
		-15°C	-10°C	-5°C	0°C	5°C	10°C	15°C	
THB4410Y	2,72	89	118	153	197	249	312	387	
THB4413Y	3,6	105	140	183	234	296	370	458	102,23
THB4415Y	4,23	131	174	227	289	361	445	541	103,69
THB4419Y	5	146	196	255	327	413	514	633	105,06
THB4422Y	5,9	193	253	324	409	510	628	766	106,40
AE4425Y	6,69	201	278	370	478	606	756	932	102,57
AE4430Y	8,02	275	365	475	608	768	959	1 183	109,02
AE4440Y	10,33	374	486	621	784	980	1 213	1 488	116,68
AE4450Y	13,24	493	642	821	1 034	1 288	1 587	1 939	136,44
AE4456Y	14,51	542	704	897	1 125	1 396	1 715	2 090	148,33
AE4460Y	15,09	560	732	934	1 172	1 453	1 785	2 174	166,77
AE4460Y	15,09	546	711	905	1 134	1 402	1 717	2 085	166,77
CAJ4452Y	15,2	415	580	778	1 018	1 308	1 656	2 070	240,62
TAJ4452Y	15,2	415	580	778	1 018	1 308	1 656	2 070	
CAJ4461Y	18,3	538	723	952	1 234	1 578	1 993	2 490	246,13
TAJ4461Y	18,3	538	723	952	1 234	1 578	1 993	2 490	263,38
CAJ4476Y	22,8	611	848	1 133	1 473	1 878	2 357	2 920	256,14
TAJ4476Y	22,8	611	848	1 133	1 473	1 878	2 357	2 920	
CAJ4492Y	25,9	774	1 065	1 415	1 833	2 333	2 928	3 620	274,89
TAJ4492Y	25,9	774	1 065	1 415	1 833	2 333	2 928	3 620	285,56
CAJ4511Y	32,7	1 064	1 429	1 864	2 380	2 990	3 709	4 552	304,84
TAJ4511Y	32,7	1 064	1 429	1 864	2 380	2 990	3 709	4 552	326,19
CAJ4513Y	34,45	1 138	1 520	1 975	2 515	3 154	3 908	4 790	323,50
FH4518Y	53,2	1 302	1 894	2 610	3 473	4 504	5 727	7 167	562,60
TFH4518Y	53,2	1 302	1 894	2 610	3 473	4 504	5 727	7 167	513,45
FH4525Y	74,25	2 093	2 901	3 874	5 040	6 432	8 082	10 023	594,50
TFH4525Y	74,25	2 093	2 901	3 874	5 040	6 432	8 082	10 023	559,04
TAG4528Y	90,2	1 655	2 557	3 709	5 113	6 769	8 677	10 838	748,94
TAG4534Y	100,7	2 355	3 388	4 695	6 277	8 134	10 267	12 676	765,79
TAG4537Y	112,5	2 760	3 904	5 358	7 124	9 203	11 594	14 299	
TAG4543Y	124,4	2 903	4 063	5 607	7 534	9 847	12 546	15 631	792,62
TAG4547Y	135	3 358	4 722	6 374	8 368	10 761	13 614	16 990	
TAGD4556Y	180,4	3 310	5 114	7 418	10 226	13 538	17 354	21 676	
TAGD4568Y	201,4	4 710	6 776	9 390	12 554	16 268	20 534	25 352	
TAGD4574Y	225	5 520	7 808	10 716	14 248	18 406	23 188	28 598	
TAGD4586Y	248,8	5 806	8 126	11 214	15 068	19 694	25 092	31 262	



Kompresory Tecumseh

R134a LBP



Typ	Objem valca cm <sup>3</sup>	Výkon pri odparovacej teplote Q [W]						Cena bez DPH Eur
		-35°C	-30°C	-25°C	-20°C	-15°C	-10°C	
AE1390Y	8,00	90	131	182	245	322	413	106,47
AE2410Y	9,40	103	151	210	278	353	432	
AE2413Y	12,00	130	188	260	346	448	565	
AE2415Y	12,50	164	225	299	391	507	652	



## Kompresory Tecumseh



R404A LBP

Typ	Objem valca cm <sup>3</sup>	Výkon pri odparovacej teplote Q [W]						Cena bez DPH Eur
		-35°C	-30°C	-25°C	-20°C	-15°C	-10°C	
THB2360Z	3,60	71	97	129	169	217	275	
THB2378Z	4,20	82	112	149	195	521	318	106,29
THB2396Z	5,20	108	145	191	247	315	395	
AE2410Z	5,02	99	142	195	259	336	427	
AE2415Z	7,33	160	220	293	382	489	617	141,90
AE2420Z	9,35	202	280	377	494	636	805	
AE2425Z	12,01	271	372	496	644	821	1 032	181,66
CAJ2428Z	15,20	252	367	511	689	906	1 169	256,82
TAJ2428Z	15,20	252	367	511	689	906	1 169	
CAJ2432Z	18,30	313	458	640	865	1 140	1 470	269,29
TAJ2432Z	18,30	313	458	640	865	1 140	1 470	
CAJ2440Z	21,00	380	547	755	1 011	1 322	1 695	266,90
CAJ2446Z	26,20	515	726	982	1 292	1 663	2 102	261,56
TAJ2446Z	26,20	515	726	982	1 292	1 663	2 102	293,31
CAJ2464Z	34,50	681	943	1 266	1 660	2 135	2 704	296,24
TAJ2464Z	34,50	681	943	1 266	1 660	2 135	2 704	302,02
FH2480Z	53,20	924	1 340	1 831	2 405	3 075	3 851	592,23
TFH2480Z	53,20	924	1 340	1 831	2 405	3 075	3 851	521,38
FH2511Z	74,20	1 224	1 794	2 504	3 376	4 433	5 697	609,91
TFH2511Z	74,20	1 224	1 794	2 504	3 376	4 433	5 697	536,93
TFHD2516Z	106,40	1 848	2 680	3 662	4 810	6 150	7 702	
TFHD2522Z	148,40	2 448	3 588	5 008	6 752	8 866	11 394	
TAG2513Z	100,70	1 260	1 991	2 920	4 083	5 517	7 261	845,04
TAG2516Z	112,50	1 923	2 660	3 652	4 917	6 473	8 338	854,00
TAG2522Z	135,00	2 206	3 203	4 454	6 008	7 917	10 239	905,99
TAG2525Z	145,00	2 475	3 572	4 913	6 539	8 490	10 815	975,95
TAGD2532Z	225,00	3 846	5 320	7 304	9 834	12 946	16 676	
TAGD2544Z	270,00	4 412	6 406	8 908	12 016	15 834	20 478	

TECUMSEH



Kompresory Tecumseh

R404A MBP



TECUMSEH

Typ	Objem valca cm <sup>3</sup>	Výkon pri odparovacej teplote Q [W]							Cena bez DPH Eur
		-15°C	-10°C	-5°C	0°C	5°C	10°C	15°C	
THB4428Z	5,20	293	374	468	580	711	867	1 050	
AE4425Z	4,24	233	304	390	495	622	775	958	
AE4430Z	5,16	290	376	479	603	751	928	1 139	
AE4440Z	6,69	392	508	648	815	1 015	1 253	1 537	134,29
AE4450Z	8,85	521	671	849	1 059	1 308	1 603	1 952	143,92
AE4460Z	10,33	645	816	1 018	1 258	1 543	1 881	2 280	154,22
AE4470Z	12,01	764	965	1 199	1 475	1 800	2 183	2 635	195,55
CAJ9480Z	15,20	833	1 080	1 375	1 728	2 149	2 650	3 245	272,88
TAJ9480Z	15,20	833	1 080	1 375	1 728	2 149	2 650	3 245	286,52
CAJ9510Z	18,30	1 048	1 354	1 720	2 157	2 679	3 300	4 038	261,99
TAJ9510Z	18,30	1 048	1 354	1 720	2 157	2 679	3 300	4 038	293,75
CAJ9513Z	24,20	1 288	1 702	2 195	2 781	3 474	4 292	5 254	276,17
TAJ9513Z	24,20	1 288	1 702	2 195	2 781	3 474	4 292	5 254	309,66
CAJ4517Z	25,95	1 493	1 929	2 446	3 062	3 794	4 662	5 689	281,68
TAJ4517Z	25,95	1 493	1 929	2 446	3 062	3 794	4 662	5 689	315,75
CAJ4519Z	34,45	1 928	2 515	3 204	4 015	4 971	6 098	7 427	292,59
TAJ4519Z	34,45	1 928	2 515	3 204	4 015	4 971	6 098	7 427	333,29
FH 4522Z	39,90	1 767	2 438	3 241	4 200	5 343	6 702	8 314	552,68
TFH 4522Z	39,90	1 767	2 438	3 241	4 200	5 343	6 702	8 314	486,55
FH 4524Z	43,50	2 082	2 840	3 729	4 768	5 977	7 380	9 002	569,65
TFH 4524Z	43,50	2 082	2 840	3 729	4 768	5 977	7 380	9 002	486,30
FH 4531Z	56,60	2 766	3 698	4 785	6 060	7 559	9 321	11 394	598,17
TFH 4531Z	56,60	2 766	3 698	4 785	6 060	7 559	9 321	11 394	506,69
FH 4540Z	74,20	3 661	4 820	6 172	7 756	9 617	11 805	14 376	618,24
TFH 4540Z	74,20	3 661	4 820	6 172	7 756	9 617	11 805	14 376	544,28
TAG4546Z	90,20	3 654	5 086	6 829	8 939	11 480	14 523	18 147	702,60
TAG4553Z	100,70	4 195	5 796	7 730	10 065	12 879	16 256	20 296	727,69
TAG4561Z	112,50	4 880	6 623	8 708	11 210	14 213	17 809	22 107	759,34
TAG4568Z	124,40	5 916	7 899	10 261	13 075	16 423	20 395	25 098	786,46
TAG4573Z	135,00	6 448	8 532	11 034	14 033	17 618	21 889	26 959	847,19
TAG4581Z	145,00	7 208	9 435	12 059	15 158	18 821	23 144	28 241	
TAGD4590Z	180,40	7 308	10 172	13 658	17 878	22 960	29 046	36 294	
TAGD4610Z	201,40	8 390	11 592	15 460	20 130	25 758	32 512	40 592	
TAGD4612Z	225,00	9 760	13 246	17 416	22 420	28 426	35 618	44 214	
TAGD4614Z	248,80	11 832	15 798	20 522	26 150	32 846	40 790	50 196	
TAGD4515Z	270,00	12 896	17 064	22 068	28 066	35 236	43 778	53 918	



DANFOSS hermetické kompresory

R134a



Typ	Kond. teplota °C	Chladiaci výkon [W] / Odparovacia teplota [°C]													Napájanie [V] 50Hz	DTN obj. kód	Cena bez DPH
		-35	-30	-25	-23,3	-20	-15	-10	-5	0	5	7,2	10	15			
BD35F	55	-	28	40	45	56	76	101	130	164	-	-	-	-	12 - 24V	101.18.1400	274,-
FR10G	55	-	113	167	188	232	308	400	510	639	791	866	968	230V	101.18.1040	132,-	
FR11G	55	-	141	209	235	287	378	487	619	777	966	-	-	230V	101.18.1045	138,-	
NL7F	55	87	122	167	186	225	293	374	-	-	-	-	-	230V	101.18.9005	112,-	
NL9F	55	98	138	191	212	256	335	427	-	-	-	-	-	230V	101.18.9006	115,-	
SC10G	55	29	74	139	166	225	331	456	600	764	946	1 032	1 147	1 367	230V	101.18.1050	175,-
SC12G	55	97	141	215	247	317	444	596	772	960	1 188	1 291	1 426	1 682	230V	101.18.1055	190,-
SC15G	55	-	-	275	314	396	542	714	910	1 132	1 378	1 494	1 649	1 945	230V	101.18.1060	205,-
SC15GH	54,4	-	-	-	-	-	-	615	796	1 008	1 255	1 376	1 541	1 872	230V	101.18.1061	283,-
SC18G	55	-	-	348	392	485	649	844	1 074	1 343	1 655	1 807	2 014	2 423	230V	101.18.1065	211,-
SC21G	55	-	-	410	456	558	746	977	1 250	1 568	1 931	2 106	2 343	2 803	230V	101.18.1070	240,-
TL4F	55	38	54	75	83	100	131	170	-	-	-	-	-	230V	101.18.9000		
TL5F	55	53	74	101	112	136	177	226	-	-	-	-	-	230V	101.18.9001		
TL5G	55	-	69	98	108	132	172	220	277	345	423	461	514	619	230V	101.18.1020	

DANFOSS



DANFOSS hermetické kompresory

R404A/R507



Typ	Kond. teplota °C	Chladiaci výkon [W] / Odparovacia teplota [°C]													Napájanie [V] 50Hz	DTN obj. kód	Cena bez DPH
		-45	-40	-35	-30	-25	-23,3	-20	-15	-10	-5	0	5	7,2			
SC10CL	45	-	-	195	300	424	470	569	737	932	1 154	-	-	-	230V	101.18.1235	197,-
SC12CL	45	67	162	275	410	568	629	754	971	1 220	1 505	-	-	-	230V	101.18.1240	202,-
SC15CL	45	-	175	347	525	714	782	920	1 149	1 407	1 699	-	-	-	230V	101.18.1245	207,-
SC18CL	45	193	313	457	628	830	907	1 067	1 342	1 659	2 022	-	-	-	230V	101.18.1250	239,-
SC21CL	45	263	378	529	719	947	1 033	1 215	1 524	1 876	-	-	-	-	230V	101.18.1255	247,-



DANFOSS hermetické kompresory

R404A/R507



Typ	Kond. teplota °C	Chladiaci výkon [W] / Odparovacia teplota [°C]													Napájanie [V] 50Hz	DTN obj. kód	Cena bez DPH
		-35	-30	-25	-23,3	-20	-15	-10	-5	0	5	7,2	10	15			
SC15DL	45	-	-	-	-	881	1 121	1 405	1 740	2 131	2 585	2 807	3 109	3 710	230V	101.18.1305	202,-

Skladom kompresory s pájkovacími prípojkami, s elektronickým príslušenstvom.



MTZ

R404A

Typ	Kond. teplota °C	Chladiaci výkon [W] / Odparovacia teplota [°C]								DTN obj. kód	Cena bez DPH
		-25	-20	-15	-10	-5	0	5	10		
MTZ018	45	750	1 130	1 600	2 170	2 860	3 680	4 650	5 770	101.18.4000	518,-
MTZ022	45	1 130	1 620	2 240	2 990	3 900	4 990	6 260	7 740	101.18.4005	527,-
MTZ028	45	1 440	2 120	2 940	3 910	5 050	6 390	7 950	9 730	101.18.4010	568,-
MTZ032	45	1 830	2 570	3 470	4 540	5 810	7 290	9 010	11 000	101.18.4015	605,-
MTZ036	45	2 230	3 090	4 120	5 320	6 740	8 380	10 300	12 400	101.18.4020	699,-
MTZ040	45	2 670	3 630	4 760	6 080	7 620	9 390	11 400	13 800	101.18.4025	728,-
MTZ044	45	2 270	3 220	4 400	5 870	7 670	9 840	12 400	15 500	101.18.4030	866,-
MTZ045	45	2 420	3 440	4 660	6 120	7 860	9 900	12 300	15 100	101.18.4035	
MTZ050	45	2 820	3 930	5 310	7 010	9 090	11 600	14 500	18 000	101.18.4040	906,-
MTZ051	45	2 890	4 030	5 440	7 130	9 170	11 600	14 400	17 700	101.18.4045	
MTZ056	45	3 050	4 410	6 040	7 980	10 300	12 900	16 000	19 600	101.18.4050	946,-
MTZ057	45	3 020	4 270	5 790	7 650	9 900	12 500	15 600	19 200	101.18.4055	
MTZ064	45	3 700	5 240	7 090	9 270	11 800	14 800	18 300	22 200	101.18.4060	995,-
MTZ065	45	3 690	5 150	6 930	9 100	11 700	14 800	18 400	22 700	101.18.4065	
MTZ072	45	4 300	6 000	8 020	10 400	13 300	16 600	20 400	24 800	101.18.4070	1 117,-
MTZ073	45	4 240	5 840	7 790	10 200	13 000	16 400	20 300	24 800	101.18.4075	
MTZ080	45	4 910	6 900	9 250	12 000	15 200	18 800	23 000	27 800	101.18.4080	1 263,-
MTZ081	45	5 230	7 080	9 300	11 900	15 000	18 700	22 900	27 700	101.18.4085	
MTZ100	45	5 690	8 000	10 700	14 000	17 800	22 300	27 500	33 500	101.18.4090	1 692,-
MTZ125	45	7 640	10 400	13 800	17 900	22 800	28 600	35 300	43 100	101.18.4095	2 024,-
MTZ144	45	9 300	12 500	16 400	21 100	26 600	33 000	40 400	48 900	101.18.4100	2 188,-
MTZ160	45	10 200	13 800	18 100	23 200	29 100	36 100	44 200	53 500	101.18.4105	2 312,-
MTZ200	45	11 400	16 000	21 500	28 000	35 700	44 600	55 000	67 000	101.18.4110	
MTZ250	45	15 300	20 800	27 600	35 800	45 600	57 200	70 700	86 300	101.18.4115	
MTZ288	45	18 600	25 100	32 900	42 200	53 100	65 900	80 800	97 800	101.18.4120	
MTZ320	45	20 500	27 600	36 200	46 300	58 300	72 300	88 400	107 000	101.18.4125	

NTZ

R404A

Typ	Kond. teplota °C	Chladiaci výkon [W] / Odparovacia teplota [°C]								DTN obj. kód	Cena bez DPH
		-45	-40	-35	-30	-25	-20	-15	-10		
NTZ048	45	190	420	710	1 240	1 700	2 240	2 860	3 570	101.18.3000	509,-
NTZ068	45	520	870	1 290	2 110	2 785	3 570	4 490	5 540	101.18.3005	522,-
NTZ096	45	-	910	1 420	2 430	3 360	4 510	5 900	7 550	101.18.3010	702,-
NTZ108	45	-	1 120	1 770	3 010	4 080	5 340	6800	8 530	101.18.3015	803,-
NTZ136	45	-	1 570	2 360	3 890	5 200	6 750	8 570	10 710	101.18.3020	1 029,-
NTZ215	45	1 190	2 240	3 540	5 970	8 030	10 440	13 220	16 420	101.18.3025	1 886,-
NTZ271	45	2 120	3 470	5 140	8 380	11 050	14 190	17 840	22 040	101.18.3030	2 052,-

Skladom kompresory s rotalock maticami, s elektronickým príslušenstvom.



SZ - Scroll

R407C

Typ	Kond. teplota °C	Chladiaci výkon [W] / Odparovacia teplota [°C]								DTN obj. kód	Cena bez DPH
		-20	-15	-10	-5	0	5	10	15		
SZ084	55	-	-	-	11 300	14 200	17 500	21 400	25 800	102.18.2000	1906,-
SZ090	55	-	-	-	12 000	15 000	18 500	22 500	27 200	102.18.2005	2014,-
SZ100	55	-	-	-	12 700	15 900	19 600	23 800	28 700	102.18.2010	2159,-
SZ110	55	-	-	-	14 500	18 100	22 300	27 200	32 700	102.18.2015	2293,-
SZ115	55	-	-	-	15 800	19 800	24 400	29 600	35 600	102.18.2020	2450,-
SZ120	55	-	-	-	17 000	21 200	26 100	31 600	38 000	102.18.2025	2502,-
SZ125	55	-	-	-	16 800	21 000	25 900	31 500	37 900	102.18.2030	2557,-
SZ148	55	-	-	-	21 200	26 200	32 100	38 900	46 700	102.18.2035	
SZ160	55	-	-	-	23 200	28 800	35 200	42 700	51 400	102.18.2040	2919,-
SZ161	55	-	-	-	22 900	28 400	34 700	42 100	50 600	102.18.2045	3124,-
SZ175	55	-	-	-	24 000	29 800	36 500	44 200	53 000	102.18.2050	3102,-
SZ185	55	-	-	-	25 700	32 000	39 200	47 500	56 900	102.18.2055	3319,-

Skladom kompresory s pájkovacími prípojkami, s elektronickým príslušenstvom. \* - verzia pre tandemové zapojenie.



COPELAND Scroll kompresory - ZR

R407C, R134a

Typ	Me-novi-tý LE	Me-novi-tý výk. (kW)	COP	Výkon (m3/h)	Verzia pripo-jov	Sacie potrubie (")	Výtláčné potrubie (")	Mazi-vo (l)	Rozmery Š / H / V (mm)	Hmot-nosť (kg)	Verzia moto-ra		DTN obj. kód	Verzia moto-ra		DTN obj. kód		Max. prúd (A)		Rozbehový prúd (A)		Hluč-nosť @1m (dBA) ***
											1 Ph*	3 Ph**		1 Ph*	3 Ph**	1 Ph*	3 Ph**	1 Ph*	3 Ph**			
ZR18K4E	1,5	3,7	3,0	4,4	522	3/4	1/2	0,74	242/242/383	20	PFJ	102.04.1000			10		35		54			
ZR22K3E	2,0	4,5	2,9	5,3		3/4	1/2	1,00	242/242/363	22	PFJ	102.04.1005	TFD	102.04.1100	11	4	47	24	54			
ZR28K3E	2,5	5,9	2,9	6,8		3/4	1/2	1,00	242/242/363	25	PFJ	102.04.1010	TFD	102.04.1105	15	5	61	32	54			
ZR34K3E	2,8	7,0	3,0	8,0		3/4	1/2	1,10	242/242/386	26	PFJ	102.04.1015	TFD	102.04.1110	17	6	76	40	57			
ZR40K3E	3,5	8,2	3,0	9,4		3/4	1/2	1,10	242/242/400	27	PFJ	102.04.1020	TFD	102.04.1115	23	7	100	46	57			
ZR48K3E	4,0	10,1	3,1	11,4	422	7/8	1/2	1,36	242/242/417	31	PFJ	102.04.1025	TFD	102.04.1120 102.04.1150	23	10	114	50	57			
ZR61KCE	5,0	12,5	3,1	14,4	522	7/8	1/2	1,66	241/247/451	43	PFZ	102.04.1033			30	11	150	65	60			
ZR61KSE	5,0	12,8	3,2	14,4		7/8	1/2	1,42	242/242/430	30			TFM	102.04.1034			11		59	61		
ZR72KCE	6,0	14,8	3,2	17,1		7/8	1/2	1,77	242/242/438	39			TFD	102.04.1125 102.04.1160			13		74	61		
ZR81KCE	6,8	16,7	3,2	18,7		7/8	3/4	1,77	242/242/446	39			TFD	102.04.1165 102.04.1130			15		101	61		
ZR94KCE	8,0	20,6	3,3	22,1		650	1 1/8	7/8	2,65	264/285/476	57			TFD	102.04.1249 102.04.1250 102.04.1251			16		95	63	
ZR108KCE	9,0	23,0	3,4	24,9	650	1 3/8	7/8	3,38	264/285/533	60			TFD	102.04.1254 102.04.1255 102.04.1256			17		111	63		
ZR125KCE	10,0	27,0	3,4	29,1	650	1 3/8	7/8	3,38	264/285/533	61			TFD	102.04.1259 102.04.1260 102.04.1261			19		118	63		
ZR144KCE	12,0	30,9	3,4	33,2	425	1 3/8	7/8	3,38	264/285/533	61			TFD	102.04.1264 102.04.1265 102.04.1266			22		118	64		
ZR160KCE	13,0	33,4	3,2	36,4	425	1 3/8	7/8	3,38	264/285/552	65			TFD	102.04.1269 102.04.1270 102.04.1271			28		140	67		
ZR190KCE	15,0	39,3	3,2	43,3	425	1 3/8	7/8	3,38	264/285/552	66			TFD	102.04.1274 102.04.1275 102.04.1276			34		174	69		
ZR250KCE	20,0	52,2	3,2	56,6	522	1 5/8 ID	1 3/8 ID	4,70	432/376/717	140			TWD	102.04.1300			41		225	72		
ZR310KCE	25,0	65,0	3,2	71,4		1 5/8 ID	1 3/8 ID	6,80	448/392/715	160			TWD	102.04.1305			52		272	74		
ZR380KCE	30,0	81,7	3,4	87,4		1 5/8	1 3/8	6,30	447/427/724	177			TWD	102.04.1310			62		310	76		

EN12900 norma: Odparovacia teplota 5°C, Kondenzačná teplota 50°C, Prehriatie 10K, Podchladenie 0K

\* 1 Ph: 230V / 50Hz

\*\* 3 Ph: 380-420V / 50Hz

\*\*\* @ 1m: Hlučnosť pri vzdialenosti 1m, vo voľnom priestranstve

Chladiaci výkon

Kondenzačná teplota +40°C															
R407C	Chladiaci výkon (kW)							R134a	Chladiaci výkon (kW)						
	Odparovacia teplota (°C)								Odparovacia teplota (°C)						
Typ	-15	-10	-5	0	5	10	15	Typ	-15	-10	-5	0	5	10	15
ZR18K4E	1,8	2,3	2,8	3,5	4,2	5,1	6,1	ZR18K4E	1,1	1,4	1,8	2,3	2,9	3,5	4,2
ZR22K3E	2,1	2,7	3,4	4,2	5,2	6,3	7,5	ZR22K3E	1,4	1,8	2,3	2,9	3,6	4,4	5,3
ZR28K3E	2,7	3,5	4,4	5,5	6,7	8,1	9,6	ZR28K3E	1,8	2,3	3,0	3,8	4,7	5,7	6,9
ZR34K3E	3,2	4,1	5,2	6,5	7,9	9,6	11,5	ZR34K3E	2,2	2,9	3,6	4,5	5,5	6,7	8,1
ZR40K3E	3,8	4,9	6,1	7,6	9,4	11,3	13,5	ZR40K3E	2,5	3,3	4,2	5,2	6,4	7,8	9,3
ZR48K3E	4,8	6,1	7,6	9,4	11,5	13,8	16,6	ZR48K3E	3,1	4,0	5,1	6,3	7,8	9,5	11,5
ZR61KCE	6,5	8,1	10,0	12,0	14,4	17,2	20,6	ZR61KCE	4,0	5,2	6,5	8,1	9,9	12,1	14,6
ZR72KCE	7,0	9,0	11,3	13,9	16,9	20,3	24,2	ZR72KCE	4,8	6,2	7,8	9,7	11,9	14,5	17,4
ZR81KCE	7,8	10,1	12,7	15,6	19,1	23,0	27,7	ZR81KCE	5,5	7,0	8,8	10,8	13,2	16,0	19,2
ZR94KCE	9,8	12,6	15,8	19,3	23,3	27,9	33,1	ZR94KCE	6,5	8,3	10,5	13,0	15,9	19,2	23,0
ZR108KCE	11,3	14,2	17,6	21,5	26,2	31,5	37,6	ZR108KCE	7,3	9,3	11,7	14,5	17,8	21,5	25,7
ZR125KCE	13,1	16,6	20,5	25,2	30,5	36,7	43,7	ZR125KCE	8,6	10,9	13,7	17,0	20,8	25,1	30,0
ZR144KCE	14,5	18,7	23,4	28,9	35,0	42,0	50,1	ZR144KCE	10,5	13,4	16,5	20,0	23,7	27,8	32,4
ZR160KCE	14,9	19,5	24,9	31,3	38,7	47,3	57,1	ZR160KCE	11,0	14,3	17,7	21,4	25,5	30,1	35,3
ZR190KCE	18,5	23,8	29,8	36,7	44,7	53,8	64,2	ZR190KCE	13,3	17,0	21,0	25,5	30,5	36,2	42,7
ZR250KCE	25,7	32,2	39,9	48,9	59,3	71,3	85,0	ZR250KCE	16,6	21,0	26,3	32,5	39,7	48,2	57,9
ZR310KCE	31,2	39,7	49,7	61,4	75,0	90,7	108,5	ZR310KCE	20,5	26,0	32,5	40,1	49,1	59,6	71,7
ZR380KCE	38,1	49,1	61,7	76,2	93,1	113,0	136,5	ZR380KCE	26,0	32,9	41,1	50,8	61,8	74,4	88,6

Prehriatie sania 10K / Podchladenie 0K



COPELAND Scroll kompresory - ZP

R410A

COPELAND

Typ	Me-novi-tý LE	Me-novi-tý výk. (kW)	COP	Výkon (m3/h)	Verzia pripo-jov	Sacie potrubie (")	Výtláčné potrubie (")	Mazi-vo (l)	Rozmery Š / H / V (mm)	Hmot-nosť (kg)	Verzia moto-ra		DTN obj. kód	Verzia moto-ra		DTN obj. kód	Max. prúd (A)		Rozbehový prúd (A)		Hluč-nosť @1m (dBA) ***
											1 Ph*	3 Ph**		1 Ph*	3 Ph**		1 Ph*	3 Ph**			
ZP24KSE	1,9	5,1	2,8	3,9	522	3/4	1/2	0,74	242/242/407	22	PFZ	102.04.2200	TFM	102.04.2250	13	5	60	28	55		
ZP29KSE	2,2	6,1	2,9	4,8		3/4	1/2	0,74	242/242/407	23	PFZ	102.04.2205	TFM	102.04.2205	16	6	67	38	55		
ZP31KSE	3,0	6,5	2,8	5,0		3/4	1/2	0,74	242/242/388	23	PFZ	102.04.2210	TFM	102.04.2260	17	6	67	38	55		
ZP36KSE	2,6	7,9	3,0	6,0		7/8	1/2	1,25	242/242/421	30	PFZ	102.04.2215	TFM	102.04.2265	22	7	98	46	57		
ZP42KSE	3,4	9,0	2,9	6,9		7/8	1/2	1,25	242/242/421	31	PFZ	102.04.2220	TFM	102.04.2270	26	8	128	43	57		
ZP54KSE	4,6	11,6	3,0	8,9		7/8	1/2	1,24	242/242/422	34	PFZ	102.04.2225	TFM	102.04.2275	31	10	115	51	69		
ZP61KCE	5,0	13,1	3,0	10,1		7/8	1/2	1,66	245/249/440	40				TFD	102.04.2075		12		64	60	
ZP72KCE	6,0	15,3	3,0	11,7		7/8	1/2	1,77	245/249/440	40				TFD	102.04.2080		15		75	64	
ZP83KCE	6,5	17,7	3,1	13,4		7/8	1/2	1,77	241/247/440	40				TFD	102.04.2085		15		101	61	
ZP91KCE	7,5	19,3	3,1	14,7		425	7/8	3/4	1,77	243/248/443	41			TFD	102.04.2091			16		101	61
625					102.04.2092																
455					102.04.2093																
ZP90KCE	7,5	19,4	3,1	14,6	425	1 1/8	7/8	2,65	264/284/476	57			TFD	102.04.2100			16		95	61	
625					102.04.2101																
455					102.04.2102																
ZP103KCE	9,0	22,4	3,2	16,7	425	1 3/8	7/8	3,38	264/284/533	59			TFD	102.04.2105			21		111	63	
625					102.04.2106																
455					102.04.2107																
ZP120KCE	10,0	26,6	3,2	19,7	425	1 3/8	7/8	3,38	264/284/533	61			TFD	102.04.2110			22		118	63	
625					102.04.2111																
455					102.04.2112																
ZP137KCE	12,0	29,9	3,2	22,1	425	1 3/8	7/8	3,38	264/284/533	61			TFD	102.04.2115			25		118	64	
625					102.04.2116																
455					102.04.2117																
ZP154KCE	13,0	33,5	3,2	24,8	425	1 3/8	7/8	3,38	264/284/552	65			TFD	102.04.2120			31		140	65	
625					102.04.2121																
455					102.04.2122																
ZP182KCE	15,0	39,6	3,2	29,1	425	1 3/8	7/8	3,38	264/284/552	66			TFD	102.04.2125			34		174	66	
625					102.04.2126																
455					102.04.2127																
ZP235KCE	20,0	50,6	3,2	37,8	522	1 5/8 ID	1 3/8 ID	4,70	432/376/717	140			TWD	102.04.2150			40		225	71	
ZP295KCE	25,0	63,5	3,2	46,7		1 5/8 ID	1 3/8 ID	6,80	448/392/725	160				TWD	102.04.2155			48		272	74
ZP385KCE	30,0	82,4	3,2	60,8		1 5/8 ID	1 3/8 ID	6,30	448/392/715	178				TWD	102.04.2160			65		310	74
ZP485KCE	40,0	105,0	3,2	77,3		1 5/8 ID	1 3/8 ID	6,30	448/392/756	190				TWD	102.04.2165			82		408	78

EN12900 norma: Odparovacia teplota 5°C, Kondenzačná teplota 50°C, Prehriatie 10K, Podchladenie 0K

\* 1 Ph: 230V / 50Hz

\*\* 3 Ph: 380-420V / 50Hz

\*\*\* @ 1m: Hlučnosť pri vzdialenosti 1m, vo voľnom priestranstve

Chladiaci výkon

Kondenzačná teplota +40°C															
R410A	Chladiaci výkon (kW)							R410	Chladiaci výkon (kW)						
	Odparovacia teplota (°C)								Odparovacia teplota (°C)						
Typ	-15	-10	-5	0	5	10	15	Typ	-15	-10	-5	0	5	10	15
ZP24KSE	2,2	3,0	3,9	4,9	5,9	7,1		ZP90KCE	10,4	12,8	15,6	18,8	22,4	26,5	31,1
ZP29KSE	2,9	3,9	4,9	6,0	7,3	8,6		ZP103KCE	11,7	14,6	17,9	21,6	25,8	30,5	35,7
ZP31KSE	3,2	4,1	5,2	6,3	7,6	9,1		ZP120KCE	14,0	17,5	21,4	25,8	30,8	36,4	42,5
ZP36KSE	4,1	5,1	6,3	7,7	9,2	11,0		ZP137KCE	15,9	19,9	24,2	29,2	34,8	41,2	48,3
ZP42KSE	4,4	5,7	7,1	8,7	10,5	12,5		ZP154KCE	18,2	22,3	27,1	32,6	38,9	46,1	54,3
ZP54KSE	6,0	7,5	9,3	11,3	13,5	16,0		ZP182KCE	21,4	26,3	32,0	38,4	45,6	53,9	63,3
ZP61KCE	6,5	8,3	10,4	12,6	15,2	18,1		ZP235KCE	26,5	32,9	40,3	48,8	58,6	69,7	82,3
ZP72KCE	8,2	10,1	12,3	14,8	17,7	20,9		ZP295KCE	34,2	41,9	50,9	61,3	73,3	86,9	102,5
ZP83KCE	9,4	11,6	14,2	17,1	20,4	24,2		ZP385KCE	43,7	53,9	65,8	79,5	95,2	113,0	133,5
ZP91KCE	10,2	12,6	15,4	18,6	22,2	26,3		ZP485KCE	57,5	70,0	84,7	101,6	121,0	143,0	168,0

Prehriatie sania 10K / Podchladenie 0K





COPELAND Scroll kompresory - ZF

R404A, R134a, R22

Typ	Meno- vitý LE	Meno- vitý výk. (kW)	COP	Výkon (m3/h)	Verzia pripojov	Sacie potrubie („)	Výtláčné potrubie („)	Mazivo (l)	Rozmery Š / H / V (mm)	Hmot- nosť (kg)	Verzia motora	Max. prúd (A)	Rozbe- hový prúd (A)	Hluč- nosť @1m (dBA) ***	DTN obj. kód
ZF06K4E	2,0	1,4	1,0	5,9	551	1 3/4	1	1,30	242/242/369	25	TFD	5	52	57	102.04.5050
ZF08K4E	2,5	1,8	1,1	7,3		1 3/4	1	1,48	243/244/392	27	TFD	6	32	59	102.04.5055
ZF09K4E	3,0	1,9	1,1	8,0		1 3/4	1	1,50	243/244/392	27	TFD	6	40	62	102.04.5060
ZF11K4E	3,5	2,5	1,1	9,9		1 3/4	1	1,50	243/244/406	28	TFD	7	46	63	102.04.5065
ZF13K4E	4,0	4,0	1,3	11,7		1 3/4	1	1,90	241/244/442	38	TFD	9	64	63	102.04.5069
ZF13K4E	4,0	2,8	1,2	11,8		1 3/4	1	1,40	241/244/490	38	TFD	8	52	65	102.04.5070
ZF15K4E	5,0	3,4	1,2	14,5		1 3/4	1	1,70	241/244/490	39	TFD	10	64	65	102.04.5075
ZF18K4E	6,0	6,0	1,5	17,1		1 3/4	1	1,90	308/246/438	39	TFD	13	74	67	102.04.5079
ZF18K4E	6,0	4,2	1,2	17,1		1 3/4	1	1,70	241/244/490	41	TFD	13	74	67	102.04.5080
ZF24K4E	7,5	5,2	1,1	20,9		1 3/4	1 1/4	4,14	368/316/542	100	TWD	16	99	72	102.04.5085
ZF24K4E	7,5	7,3	1,4	20,9		1 3/4	1 1/4	4,14	316/368/542	100	TWD	16	99	70	102.04.5086
ZF33K4E	10,5	7,1	1,2	28,8		1 3/4	1 1/4	4,14	368/319/525	93	TWD	22	127	72	102.04.5015
ZF33K4E	10,5	9,9	1,4	28,8		13/4	1 1/4	4,14	368/319/525	93	TWD	21	127	72	102.04.5091
ZF40K4E	12,5	12,0	1,5	35,6		1 3/4	1 1/4	4,14	316/368/550	96	TWD	27	167	72	102.04.5094
ZF40K4E	12,5	8,8	1,2	35,6		1 3/4	1 1/4	4,14	368/324/532	103	TWD	25	167	72	102.04.5095
ZF48K4E	15,0	10,6	1,1	42,8		2 1/4	1 1/4	4,14	324/294/579	112	TWD	29	198	72	102.04.5100
ZF48K4E	15,0	15,0	1,5	42,8		2 1/4	1 3/4	4,14	324/294/579	112	TWD	31	198	72	102.04.5101

„Summit“ kompresory

ZF25K6E	7,5	5,1	1,2	21,3	551	1 1/4	1	1,90	308/246/438	41	TFD	14	90	68	102.04.5105
ZF34K6E	9,0	6,8	1,2	21,3		1 3/4	1 1/4	3,20	280/279/456	63	TFD	19	100	68	102.04.5110
ZF41K6E	10,0	8,0	1,3	35,3		1 3/4	1 1/4	3,20	280/279/546	63	TFD	21	118	69	102.04.5115
ZF49K6E	13,0	10,1	1,2	42,3		1 3/4	1 1/4	3,20	280/279/564	63	TFD	31	118	71	102.04.5120

EN12900 norma: Odparovacia teplota 5°C, Kondenzačná teplota 50°C, Prehriatie 10K, Podchladenie 0K

\* 1 Ph: 230V / 50Hz

\*\* 3 Ph: 380-420V / 50Hz

\*\*\* @ 1m: Hlučnosť pri vzdialenosti 1m, vo voľnom priestranstve

Chladiaci výkon

		Kondenzačná teplota +40°C															
R404A	Typ	Chladiaci výkon (kW)							R22	Typ	Chladiaci výkon (kW)						
		Odparovacia teplota (°C)									Odparovacia teplota (°C)						
		-35	-30	-25	-20	-15	-10	-5			-35	-30	-25	-20	-15	-10	-5
ZF06K4E		1,4	1,8	2,2	2,6	3,1	3,8	4,5	ZF09K4E		1,8	2,3	2,8	3,5	4,2	5,1	6,1
ZF08K4E		1,8	2,2	2,8	3,4	4,1	4,8	5,7	ZF11K4E		2,3	2,9	3,5	4,3	5,2	6,3	7,5
ZF09K4E		1,9	2,4	3,0	3,6	4,4	5,2	6,3	ZF13K4E		2,7	3,3	4,1	5,0	6,1	7,3	8,7
ZF11K4E		2,5	3,0	3,7	4,5	5,4	6,5	7,8	ZF15K4E		3,2	4,1	5,0	6,1	7,4	8,9	10,6
ZF13K4E		2,8	3,5	4,3	5,3	6,4	7,7	9,1	ZF18K4E		3,8	4,8	5,9	7,3	8,8	10,7	12,7
ZF15K4E		3,4	4,3	5,3	6,4	7,8	9,4	11,2	ZF24K4E		4,8	5,9	7,3	8,9	10,8	13,1	15,6
ZF18K4E		4,2	5,2	6,4	7,8	9,4	11,3	13,5	ZF33K4E		6,2	7,9	9,9	12,3	15,0	18,1	21,4
ZF24K4E		5,2	6,4	7,9	9,6	11,6	13,8	16,4	ZF40K4E		8,3	10,2	12,4	15,1	18,4	22,2	26,7
ZF33K4E		7,1	8,9	10,9	13,3	16,1	19,3	23,0	ZF48K4E		9,2	11,5	14,1	17,3	21,1	25,5	30,6
ZF40K4E		8,8	11,0	13,5	16,4	19,8	23,7	28,2									
ZF48K4E		10,6	13,2	16,3	20,0	24,1	28,9	34,4									

KVE modely so vstrekaním chladiva							
Typ	-35	-30	-25	-20	-15	-10	-5
ZF13K4E	4,0	4,9	6,0	7,2	8,6	10,1	11,7
ZF18K4E	6,0	7,1	8,5	10,1	11,9	14,0	16,4
ZF24K4E	7,3	8,9	10,7	12,7	15,0	17,5	20,4
ZF33K4E	9,9	12,0	14,5	17,3	20,4	24,1	28,1
ZF40K4E	12,0	15,3	18,8	22,5	26,5	30,9	35,7
ZF48K4E	15,0	18,2	21,8	25,7	30,0	34,7	39,9

„Summit“ - so vstrekaním kvapalného chladiva							
Typ	-35	-30	-25	-20	-15	-10	-5
ZF25K6E	5,1	6,3	7,8	9,6	11,7	14,1	16,8
ZF34K6E	6,8	8,5	10,4	12,6	15,3	18,3	21,8
ZF41K6E	8,0	10,0	12,3	14,9	18,0	21,5	25,7
ZF49K6E	10,7	13,3	16,4	20,0	24,1	28,9	34,3

„Summit“ - so vstrekaním horúcich pár							
Typ	-35	-30	-25	-20	-15	-10	-5
ZF25K6E	7,8	9,5	11,4	13,5	15,9	18,5	21,4
ZF34K6E	10,2	12,4	14,9	17,6	20,7	24,1	27,8
ZF41K6E	12,6	15,3	18,3	21,7	25,5	29,6	34,2
ZF49K6E	15,1	18,3	21,9	26,0	30,5	35,5	41,0

Teplota sania 20°C / Podchladenie 0K

COPELAND SCROLL



COPELAND Scroll kompresory - ZB

R404A, R407C, R134a, R22

COPELAND SCROLL

Typ	Me-novi-tý LE	Me-novi-tý výk. (kW)	COP	Výkon (m3/h)	Verzia prípo-jov	Sacie potrubie (")	Výtlačné potrubie (")	Mazi-vo (l)	Rozmery Š / H / V (mm)	Hmot-nosť (kg)	Verzia moto-ra		DTN obj. kód	Verzia moto-ra		DTN obj. kód	Max. prúd (A)		Rozbehový prúd (A)		Hlučnosť @1m (dBA) ***
											1 Ph*	3 Ph**		3 Ph**	DTN obj. kód		1 Ph*	3 Ph**	1 Ph*	3 Ph**	
ZB15KCE	2,0	3,3	1,8	5,9	551	3/4	1/2	1,30	241/241/382	25	PFJ	102.04.3000	TFD	102.04.3050	13	5	58	26	55		
ZB19KCE	2,5	4,2	2,0	6,8		1 1/4	1	1,50	242/242/369	27	PFJ	102.04.3005	TFD	102.04.3055	13	7	61	32	55		
ZB21KCE	3,0	5,1	2,0	8,6		1 1/4	1	1,24	243/244/392	29	PFJ	102.04.3010	TFD	102.04.3060	16	7	82	40	58		
ZB26KCE	3,5	5,8	2,0	10,0		1 1/4	1	1,45	243/244/406	28	PFJ	102.04.3015	TFD	102.04.3065	18	9	97	46	58		
ZB29KCE	4,0	6,8	2,1	11,4		1 1/4	1	1,50	242/242/423	29				TFD	102.04.3069		10		50	59	
ZB30KCE	4,0	6,9	2,0	11,7		1 1/4	1	1,90	242/242/438	35	PFJ	102.04.3020	TFD	102.04.3070	26	10	142	49	59		
ZB38KCE	5,0	8,5	2,0	14,4		1 1/4	1	1,90	242/242/438	37	PFJ	102.04.3025	TFD	102.04.3075	32	13	142	66	61		
ZB42KCE	5,5	9,7	2,1	16,2		1 1/4	1	1,90	251/246/450	40	PFJ	102.04.3030				36		150		62	
ZB45KCE	6,0	10,1	2,1	17,1		1 1/4	1	1,90	242/242/458	40				TFD	102.04.3080		13		74	61	
ZB48KCE	7,0	11,6	2,1	18,8		1 1/4	1 1/4	1,80	241/247/456	39				TFD	102.04.3084		14		101	62	
ZB50KCE	7,0	11,9	2,1	19,8		1 1/8	7/8	2,65	264/284/480	57				TFD	102.04.3085		15		100	64	
ZB58KCE	8,0	13,3	2,1	22,1		1 3/4	1 1/4	2,65	264/284/478	57				TFD	102.04.3095		15		95	65	
ZB66KCE	9,0	15,1	2,1	24,9		1 3/4	1 1/4	3,38	264/284/533	60				TFD	102.04.3100		18		111	66	
ZB76KCE	10,0	17,9	2,2	29,1		1 3/4	1 1/4	3,38	264/284/546	61				TFD	102.04.3110		20		118	66	
ZB95KCE	13,0	21,7	2,1	36,4		1 3/4	1 1/4	3,38	264/285/552	65				TFD	102.04.3120		28		140	67	
ZB114KCE	15,0	25,8	2,0	43,4		1 3/4	1 1/4	3,38	264/285/552	66				TFD	102.04.3130		33		174	71	
ZB220KCE	30,0	53,2	2,2	87,5			2 1/4 x 12UN	1 3/4 x 12un	6,3	448/392/717	176			TWM	102.04.3150		69		310	78	

EN12900 norma: MT, Odparovacia teplota -10°C, Kondenzačná teplota 45°C, Teplota sania 20°C / Podchladienie 0K

\* 1 Ph: 230V / 50Hz

\*\* 3 Ph: 380-420V / 50Hz

\*\*\* @ 1m: Hlučnosť pri vzdialenosti 1m, vo voľnom priestranstve

Chladiaci výkon

Kondenzačná teplota +40°C															
R404A	Chladiaci výkon (kW)						R407C	Chladiaci výkon (kW)							
	Odparovacia teplota (°C)							Odparovacia teplota (°C)							
Typ	-35	-30	-25	-20	-15	-10	-5	Typ	-35	-30	-25	-20	-15	-10	-5
ZB15KCE		1,4	1,9	2,4	3,0	3,7	4,5	ZB15KCE			1,6*	2,1*	2,8	3,5	4,2
ZB19KCE		2,0	2,5	3,1	3,8	4,5	5,4	ZB19KCE			2,1*	2,6*	3,4	4,2	5,2
ZB21KCE		2,4	3,0	3,7	4,5	5,5	6,6	ZB21KCE			2,5*	3,2*	4,1	5,1	6,2
ZB26KCE		2,8	3,5	4,3	5,3	6,4	7,6	ZB26KCE			2,6*	3,6*	4,7	5,8	7,1
ZB29KCE	2,1*	3,2	4,1	5,0	6,2	7,5	9,0	ZB30KCE			3,4*	4,4*	5,8	7,3	8,9
ZB30KCE	2,1*	3,2	4,1	5,0	6,2	7,5	9,0	ZB38KCE			4,2*	5,4*	7,2	8,9	11
ZB38KCE	2,7*	4,1	5,1	6,3	7,7	9,3	11,2	ZB45KCE			4,9*	6,3*	8,2	10,2	12,4
ZB42KCE**		4,6	5,7	7,1	8,7	10,6	12,7								
ZB45KCE	3,2*	4,8	6,0	7,4	9,1	11,0	13,2								
ZB48KCE	3,6*	5,5	6,9	8,6	10,5	12,7	15,2								
ZB50KCE		2,8*	5,9	8,2	10,6	13,1	15,8								
ZB58KCE		4,2*	7,2	9,4	11,9	14,5	17,5								
ZB66KCE		6,0*	8,9	11,1	13,6	16,4	19,7								
ZB76KCE		7,0*	10,4	13,0	16,0	19,4	23,3								
ZB95KCE		7,6*	10,7*	15,6	19,5	23,8	28,7								
ZB114KCE		8,5*	12,3*	18,3	23,0	28,3	24,4								
ZB220KCE			28,4*	39,2	47,7	57,5	68,9								

R134a	Chladiaci výkon (kW)						
	Odparovacia teplota (°C)						
Typ	-35	-30	-25	-20	-15	-10	-5
ZB15KCE				1,4	1,7	2,2	2,7
ZB19KCE				1,6	2,0	2,5	3,2
ZB21KCE				2,0	2,5	3,2	4,0
ZB26KCE				2,3	2,9	3,7	4,6
ZB30KCE				2,5*	3,4	4,3	5,4
ZB38KCE				3,0*	4,2	5,4	6,7
ZB42KCE**				3,8	4,8	6,0	7,5
ZB45KCE				3,8*	5,1	6,4	8,0
ZB50KCE				4,6	5,9	7,4	9,1
ZB58KCE				5,2	6,6	8,3	10,3
ZB66KCE				6,0	7,6	9,5	11,8
ZB76KCE				6,9	8,6	10,8	13,5
ZB95KCE				8,2	10,8	13,8	17,1
ZB114KCE				9,6	12,7	16,3	20,4

R22	Chladiaci výkon (kW)						
	Odparovacia teplota (°C)						
Typ	-35	-30	-25	-20	-15	-10	-5
ZB15KCE			1,4*	2,1*	2,8*	3,5	4,2
ZB19KCE			1,9*	2,5*	3,2*	4,0	4,8
ZB21KCE			2,0*	3,0*	4,0*	5,1	6,2
ZB26KCE			2,7*	3,5*	4,4*	5,6	6,8
ZB30KCE			2,2*	3,2*	4,5*	6,0	7,7
ZB38KCE			3,8*	4,9*	6,3*	8,0	10,0
ZB42KCE**			5,2*	6,6*	8,1*	9,9	11,9
ZB45KCE			4,5*	6,4*	8,3*	10,3	12,5
ZB50KCE			4,6*	6,9*	9,2*	11,7	14,4
ZB58KCE			5,1*	7,5*	10,1*	13,0	16,1
ZB66KCE			7,4*	9,6*	12,2*	15,1	18,4
ZB76KCE			8,9*	11,5*	14,4*	17,8	21,7
ZB95KCE					16,8*	21,4*	26,5*
ZB114KCE					19,9*	25,5*	31,7*

Teplota sania 20°C / Podchladienie 0K

\* Prehriatie sania 10K / Podchladienie 0K

\*\* Iba jednofázové

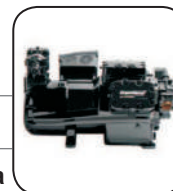

DWM COPELAND polohermetické kompresory - Stream - HFC

R404A, R134a

Typ	Menovitý LE	Výkon (m3/h)	Normálna teplota				Nízka teplota		Hmotnosť (kg)	Rozmer nôh (mm)	DTN obj. kód
			Chladiaci výkon (kW)		COP		Chladiaci výkon** (kW)	COP**			
			R404A*	R134a***	R404A*	R134a***					
4MF-13X	13	62	33,4	18,2	2,3	2,4	11,4	1,4	177	111.04.4000	
4MA-22X	22	62	33,6	19,1	2,4	2,6	10,8	1,4	178	111.04.4005	
4ML-15X	15	71	38,7	22,1	2,3	2,3	13,2	1,5	180	111.04.4010	
4MH-25X	25	71	38,8	21,4	2,4	2,3	12,5	1,4	187	111.04.4015	
4MM-20X	20	78	42,6	24,7	2,3	2,4	14,7	1,5	182	111.04.4020	
4MI-30X	30	78	42,8	23,9	2,4	2,4	13,9	1,4	188	111.04.4025	
4MT-22X	22	88	47,8	27,7	2,3	2,4	16,5	1,5	183	111.04.4030	
4MJ-33X	33	88	48,0	26,8	2,3	2,4	16,0	1,4	190	111.04.4035	
4MU-25X	25	99	54,2	31,2	2,3	2,4	18,7	1,5	186	111.04.4040	
4MK-35X	35	99	54,4	30,1	2,4	2,3	17,7	1,4	202	111.04.4045	
6MM-30X	30	120	61,8	36,9	2,3	2,3	21,6	1,4	215	111.04.4050	
6MI-40X	40	120	64,2	35,3	2,4	2,3	20,3	1,4	219	111.04.4055	
6MT-35X	35	135	70,4	41,3	2,3	2,3	25,1	1,5	221	111.04.4060	
6MJ-45X	45	135	72,4	40,4	2,3	2,4	23,6	1,4	223	111.04.4065	
6MU-40X	40	153	79,8	46,3	2,3	2,3	28,4	1,4	225	111.04.4070	
6MK-50X	50	153	82,1	45,3	2,3	2,3	26,6	1,4	230	111.04.4075	

DWM COPELAND

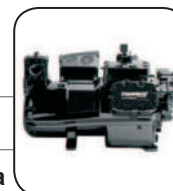

DWM COPELAND polohermetické kompresory - Stream - HFC Digital

R404A, R134a

Typ	Menovitý LE	Výkon (m3/h)	Normálna teplota				Nízka teplota		Hmotnosť (kg)	Rozmer nôh (mm)	DTN obj. kód
			Chladiaci výkon (kW)		COP		Chladiaci výkon** (kW)	COP**			
			R404A*	R134a***	R404A*	R134a***					
4MFD-13X	13	62	33,4	18,2	2,3	2,4	11,4	1,4	177	111.04.4100	
4MAD-22X	22	62	33,6	19,1	2,4	2,6	10,8	1,4	178	111.04.4105	
4MLD-15X	15	71	38,7	22,1	2,3	2,3	13,2	1,5	180	111.04.4110	
4MHD-25X	25	71	38,8	21,4	2,4	2,3	12,5	1,4	187	111.04.4115	
4MMD-20X	20	78	42,6	24,7	2,3	2,4	14,7	1,5	182	111.04.4120	
4MID-30X	30	78	42,8	23,9	2,4	2,4	13,9	1,4	188	111.04.4125	
4MTD-22X	22	88	47,8	27,7	2,3	2,4	16,5	1,5	183	111.04.4130	
4MJD-33X	33	88	48,0	26,8	2,3	2,4	16,0	1,4	190	111.04.4135	
4MUD-25X	25	99	54,2	31,2	2,3	2,4	18,7	1,5	186	111.04.4140	
4MKD-35X	35	99	54,4	30,1	2,4	2,3	17,7	1,4	202	111.04.4145	
6MMD-30X	30	120	61,8	36,9	2,3	2,3	21,6	1,4	215	111.04.4150	
6MID-40X	40	120	64,2	35,3	2,4	2,3	20,3	1,4	219	111.04.4155	
6MTD-35X	35	135	70,4	41,3	2,3	2,3	25,1	1,5	221	111.04.4160	
6MJD-45X	45	135	72,4	40,4	2,3	2,4	23,6	1,4	223	111.04.4165	
6MUD-40X	40	153	79,8	46,3	2,3	2,3	28,4	1,4	225	111.04.4170	
6MKD-50X	50	153	82,1	45,3	2,3	2,3	26,6	1,4	230	111.04.4175	



BITZER polohermetické kompresory



R404A/R507A

BITZER

Typ	Prietok chladiva 1450 min <sup>-1</sup> (m <sup>3</sup> /h)	Počet valcov	Maziwo (dm <sup>3</sup> )	Hmotnosť (kg)	Rozmery Š / H / V (mm)	Pripoje				Riadenie výkonu (%)	Údaje napájania		
						DL výtlačné potrubie		SL sacie potrubie			Typ napájania (1)	Max. prúd (A)	Max. príkon (kW)
						mm	zoll	mm	zoll				
2KES-05(Y)	4,06	2	1,0	43	343/220/273	12	1/2	16	5/8	-	Δ / Y	4,9/2,8	1,5
2JES-07(Y)	5,21	2	1,0	43		12	1/2	16	5/8			6,4/3,7	1,9
2HES-1(Y)	6,51	2	1,0	44		12	1/2	16	5/8			6,7/3,8	2,0
2HES-2(Y)				45		7,8/4,5	2,4						
2GES-2(Y)	7,58	2	1,0	45		12	1/2	16	5/8			8,7/5,0	2,7
2FES-2(Y)	9,54	2	1,0	45		12	1/2	16	5/8			9,2/5,3	2,9
2FES-3(Y)				47		10,7/6,1	3,4						
2EES-2(Y)	11,4	2	1,5	68	398/259/307	16	5/8	22	7/8			10,4/6,0	3,3
2EES-3(Y)				71								13,4/7,5	3,8
2DES-2(Y)	13,4	2	1,5	68		16	5/8	22	7/8			13,4/7,5	4,0
2DES-3(Y)				71		15,0/8,6	4,6						
2CES-3(Y)	16,2	2	1,5	70		16	5/8	22	7/8			15,8/9,1	5,0
2CES-4(Y)				70		17,4/10,0	5,6						
4FES-3(Y)	18,1	4	2,0	82		432/309/347	16	5/8	22			7/8	16,5/9,5
4FES-5(Y)				86						18,8/10,8	5,8		
4EES-4(Y)	22,7	4	2,0	84			16	5/8	28	1 1/8	21,2/12,2	6,9	
4EES-6(Y)				86			23,7/13,6	7,6					
4DES-5(Y)	26,8	4	2,0	86			22	7/8	28	1 1/8	25,2/14,5	8,1	
4DES-7(Y)				89							28,7/16,5	8,9	
4CES-6(Y)	32,5	4	2,0	91			457/309/352	22	7/8	28	1 1/8	30,8/17,7	9,7
4CES-9(Y)				91								35,1/20,2	11,3
4VES-6Y	34,7	4	2,6	129	633/303/385			22	7/8	28	1 1/8	9,4	6
4VES-7(Y)				129								16,6	11
4VES-10(Y)				139								19,9	12
4TES-8Y				134								11,4	7
4TES-9(Y)	41,3	4	2,6	134				28	1 1/8	35	1 3/8	19,9	13
4TES-12(Y)				141								25,1	14
4PES-10Y	48,5	4	2,6	139		28		1 1/8	35	1 3/8	12,9	8	
4PES-12(Y)				139							22,7	14	
4PES-15(Y)				147					28,2	16			
4NES-12Y				141					14,9	9			
4NES-14(Y)	56,2	4	2,6	141		28		1 1/8	35	1 3/8	26,6	17	
4NES-20(Y)				150							33,2	19	
4JE-13Y	63,5	4	4,0	179		688/456/452	28	1 1/8	42	1 5/8	18,8	11	
4JE-15(Y)				190							30,8	19	
4JE-22(Y)				190	37,2						21		
4HE-15Y				183	21,4						13		
4HE-18(Y)	73,7	4	4,0	190	28		1 1/8	42	1 5/8	36,7	22		
4HE-25(Y)				194						44	25		
4GE-20Y	84,6	4	4,5	192	28		1 1/8	54	2 1/8	24,6	16		
4GE-23(Y)				192						43,9	27		
4GE-30(Y)				206						51,2	28		
4FE-25Y				196						30,5	19		
4FE-28(Y)	101,8	4	4,5	207	28		1 1/8	54	2 1/8	52,8	31		
4FE-35(Y)				207						62,1	35		
6JE-22Y	95,3	6	4,75	213	766/503/447		35	1 3/8	54	2 1/8	26,6	16	
6JE-25(Y)				228							46,4	27	
6JE-33(Y)				231		53,2					30		
6HE-25Y	110,5	6	4,75	224		35	1 3/8	54	2 1/8	31,3	19		
6HE-28(Y)				228						53,2	33		
6HE-35(Y)				235						64,4	36		
6GE-30Y	126,8	6	4,75	228		35	1 3/8	54	2 1/8	38	23		
6GE-34(Y)				228						65,5	40		
6GE-40(Y)				238						73,9	42		
6FE-40Y				238						48,5	27		
6FE-44(Y)	151,6	6	4,75	241		42	1 5/8	54	2 1/8	83,2	46		
6FE-50(Y)				241						96,2	51		
8GE-50(Y)	185	8	5,0	342		886/485/538	42	1 5/8	54	3 1/8	92	51	
8GE-60(Y)				350							113	63	
8FE-60(Y)	221	8	5,0	361	54		2 1/8	76	3 1/8	113	63		
8FE-70(Y)				374						139	78		



## BITZER polohermetické kompresory

R404A/R507A

Typ	Kond. teplota °C	Chladiaci výkon [W] / Odparovacia teplota [°C]										DTN obj. kód
		5	0	-5	-10	-15	-20	-25	-30	-35	-40	
2KES-05Y	50	2810	2320	1890	1520	1190	910	670	460	285	140	111.09.1000
2JES-07Y	50	3850	3190	2620	2120	1680	1300	980	700	465	265	111.09.1005
2HES-1Y	50		4000	3290	2670	2130	1660	1250	905	615	365	111.09.1010
2HES-2Y	50	4940	4110	3380	2740	2190	1700	1290	935	630	375	111.09.1015
2GES-2Y	50	5650	4710	3890	3180	2560	2020	1560	1160	825	540	111.09.1020
2FES-2Y	50		5770	4770	3900	3140	2480	1910	1420	1000	650	111.09.1025
2FES-3Y	50	6890	5760	4760	3890	3130	2470	1900	1410	995	645	111.09.1030
2EES-2Y	50		7490	6180	5040	4050	3190	2450	1820	1280	830	111.09.1035
2EES-3Y	50	8980	7490	6180	5040	4050	3190	2450	1820	1280	830	111.09.1040
2DES-2Y	50		8960	7420	6070	4890	3870	2990	2240	1600	1070	111.09.1045
2DES-3Y	50	10720	8960	7420	6070	4890	3870	2990	2240	1600	1070	111.09.1050
2CES-3Y	50		11060	9180	7540	6120	4880	3810	2890	2110	1450	111.09.1055
2CES-4Y	50	13190	11060	9180	7540	6120	4880	3810	2890	2110	1450	111.09.1060
4FES-3Y	50		12030	9940	8140	6580	5250	4120	3170	2380	1730	111.09.1065
4FES-5Y	50	14400	12010	9940	8130	6580	5250	4130	3180	2380	1730	111.09.1070
4EES-4Y	50		15360	12690	10380	8390	6690	5240	4020	3010	2170	111.09.1075
4EES-6Y	50	18240	15170	12510	10200	8220	6520	5080	3870	2870	2040	111.09.1080
4DES-5Y	50		18440	15220	12440	10040	8000	6260	4800	3600	2600	111.09.1085
4DES-7Y	50	22150	18430	15220	12440	10040	8000	6260	4810	3600	2600	111.09.1090
4CES-6Y	50		22500	18520	15080	12120	9610	7480	5690	4220	3010	111.09.1095
4CES-9Y	50	27100	22500	18520	15080	12120	9610	7480	5690	4220	3010	111.09.1100
4VES-7Y	50		23550	19180	15430	12210	9480	7190	5280	3710	2440	111.09.1105
4VES-10Y	50	28600	23550	19180	15420	12200	9480	7190	5280	3720	2470	111.09.1110
4TES-9Y	50		28500	23300	18860	15040	11780	9030	6740	4840	3300	111.09.1115
4TES-12Y	50	34450	28500	23300	18810	14990	11730	9000	6720	4850	3330	111.09.1120
4PES-12Y	50		32550	26500	21250	16790	13010	9830	7200	5040	3300	111.09.1125
4PES-15Y	50	39450	32400	26350	21150	16680	12920	9760	7140	5000	3280	111.09.1130
4NES-14Y	50		38550	31550	25500	20350	15950	12240	9140	6580	4510	111.09.1135
4NES-20Y	50	46800	38700	31700	25650	20450	16070	12380	9310	6780	4740	111.09.1140
4JE-15Y	50		44200	36500	29850	24050	19080	14810	11200	8160	5640	111.09.1145
4JE-22Y	50	51900	43200	35500	28850	23100	18150	13930	10350	7350	4860	111.09.1150
4HE-18Y	50		51400	42650	35000	28350	22600	17720	13570	10070	7160	111.09.1155
4HE-25Y	50	60700	50700	41900	34250	27600	21900	17040	12910	9440	6560	111.09.1160
4GE-23Y	50		59300	49300	40600	33050	26550	21000	16290	12320	9010	111.09.1165
4GE-30Y	50	69400	57900	48000	39300	31800	25350	19820	15140	11210	7950	111.09.1170
4FE-28Y	50		70100	58600	48500	39650	32000	25350	19630	14710	10520	111.09.1175
4FE-35Y	50	82600	69500	58000	47900	39100	31500	24850	19140	14240	10070	111.09.1180
6JE-25Y	50		66100	54600	44550	35900	28450	22100	16750	12260	8540	111.09.1185
6JE-33Y	50	77400	64300	52800	42800	34200	26800	20500	15210	10780	7130	111.09.1190
6HE-28Y	50		75700	62800	51500	41750	33300	26100	19970	14800	10490	111.09.1195
6HE-35Y	50	89300	74500	61600	50400	40650	32250	25100	18970	13840	9570	111.09.1200
6GE-34Y	50		87200	72800	60300	49400	39950	31800	24850	18920	13930	111.09.1205
6GE-40Y	50	100400	84100	69900	57400	46550	37200	29100	22200	16390	11490	111.09.1210
6FE-44Y	50		104400	87200	72200	59100	47650	37750	29250	21900	15660	111.09.1215
6FE-50Y	50	121700	102200	85100	70100	57100	45700	35850	27400	20150	13970	111.09.1220
8GE-60Y	50	140300	117900	98200	80900	65600	52200	40450	30100			111.09.1225
8FE-70Y	50	166100	139600	116300	95700	77700	61800	47900	35650			111.09.1230

 (1) Odchýlka ( $\pm 10\%$ ) pre strednú hodnotu napájania. Iné druhy napájania na dopyt.

 (2) PW - (Part Winding) motor s postupným pripájaním vinutí  $\Delta/Y$  na dopyt.

DORIN polohermetické kompresory

R404A



DORIN

Séria	Model	Kond. teplota [°C]	Chladiaci výkon Q [W] - R404A										Cena bez DPH Eur	
			Odparovacia teplota											
			5	0	-5	-10	-15	-20	-25	-30	-35	-40		
H11	H51CS	45							1 320	1 040				863,-
	H80CC	45		3 020	2 500	2 050	1 660	1 330	1 040	785				871,-
	H80CS	45					2 150	1 720	1 350	1 030	770	545		871,-
	H101CC	45			3 260	2 660	2 140	1 690	1 310	980	705	470		877,-
	H101CS	45					2 560	2 050	1 610	1 230	915	650		877,-
	H151CC	45		4 700	3 890	3 190	2 580	2 050	1 600	1 210	875	595		887,-
	H151CS	45					3 560	2 900	2 330	1 840	1 420	1 060	745	887,-
	H181CC	45	6 350	5 310	4 390	3 580	2 890	2 290	1 780	1 350	985	680		898,-
	H181CS	45			5 390	4 430	3 590	2 870	2 250	1 720	1 280	900		898,-
	H201CC	45	7 690	6 430	5 340	4 400	3 590	2 880	2 260	1 710	1 210	735		943,-
	H201CS	45				4 770	3 880	3 100	2 430	1 860	1 380	965		943,-
	H221CC	45	8 380	7 010	5 810	4 750	3 840	3 050	2 370	1 790	1 290	870		972,-
	H221CS	45			6 320	5 190	4 200	3 350	2 620	2 000	1 480	1 040		972,-
	H251CC	45	9 000	7 530	6 250	5 120	4 150	3 310	2 600	1 990	1 470	1 040		972,-
	H251CS	45			7 050	5 790	4 700	3 750	2 930	2 240	1 650	1 140		1 015,-
	H281CC	45	10 080	8 430	6 970	5 700	4 600	3 640	2 820	2 120	1 520	1 010		1 015,-
H281SB	45					6 350	5 130	4 070	3 170	2 400	1 750	1 210	1 048,-	
H281CS	45			7 750	6 350	5 130	4 070	3 170	2 400	1 750	1 210		1 055,-	
H290CS	45			8 730	7 170	5 810	4 640	3 630	2 770	2 050	1 440		1 143,-	
H2	H300CC	45	12 630	10 550	8 730	7 140	5 760	4 580	3 570	2 710	1 990	1 380	1 174,-	
	H300CS	45			9 410	7 750	6 300	5 050	3 980	3 060	2 290	1 640	1 174,-	
	H350CC	45	13 620	11 420	9 490	7 800	6 340	5 080	4 000	3 080	2 310	1 650	1 174,-	
	H350SB	45					6 980	5 630	4 460	3 470	2 630	1 920	1 174,-	
	H380CC	45	14 980	12 580	10 480	8 640	7 050	5 670	4 500	3 490	2 640	1 920	1 368,-	
	H380SB	45						6 360	5 070	3 980	3 060	2 280	1 208,-	
	H390CS	45				9 610	7 880	6 380	5 100	4 000	3 070	2 290	1 368,-	
	H392CS	45							5 890	4 530	3 370	2 400	1 421,-	
H33	H355CS	45			11 780	9 610	7 730	6 110	4 740	3 580	2 630	1 850	1 693,-	
	H405CC	45	17 660	14 590	11 920	9 610	7 640	5 970	4 580	3 440	2 510	1 760	1 727,-	
	H405CS	45			14 140	11 550	9 300	7 370	5 720	4 330	3 160	2 210	1 727,-	
	H505CC	45	21 040	17 430	14 280	11 550	9 200	7 210	5 540	4 150	3 020	2 100	1 762,-	
	H505CS	45			16 560	13 550	10 930	8 680	6 760	5 140	3 790	2 670	1 786,-	
	H705CC	45	24 720	20 520	16 850	13 660	10 920	8 590	6 630	5 000	3 660	2 570	1 832,-	
	H705CS	45			19 220	15 750	12 730	10 130	7 910	6 040	4 480	3 190	1 832,-	
H755CC	45	28 710	23 870	19 630	15 950	12 790	10 090	7 820	5 920	4 350	3 080	1 879,-		
H35	H551CS	45			16 180	13 280	10 760	8 580	6 710	5 110	3 760	2 620	2 008,-	
	H701CC	45	24 280	20 150	16 540	13 410	10 730	8 450	6 540	4 940	3 620	2 530	2 052,-	
	H701CS	45			18 400	15 110	12 240	9 760	7 630	5 810	4 280	2 980	2 052,-	
	H751CC	45	27 770	23 040	18 910	15 340	12 270	9 670	7 470	5 640	4 130	2 890	2 097,-	
	H751CS	45			22 230	18 250	14 790	11 790	9 220	7 030	5 180	3 610	2 097,-	
H35	H1002CC	45	33 150	27 500	22 570	18 310	14 650	11 540	8 920	6 740	4 930	3 450	2 124,-	
	H801CS	45			25 890	21 250	17 220	13 730	10 730	8 180	6 020	4 200	2 153,-	
	H1003CC	45	38 470	31 920	26 200	21 250	17 000	13 390	10 350	7 820	5 720	4 010	2 183,-	
H41	H851CS	45			26 610	21 870	17 740	14 160	11 100	8 480	6 270	4 400	2 243,-	
	H1201CC	45	38 530	32 240	26 700	21 880	17 690	14 090	11 010	8 390	6 170	4 290	2 360,-	
	H1001CS	45			30 690	25 260	20 530	16 440	12 920	9 910	7 360	5 200	2 403,-	
	H1501CC	45	43 600	36 540	30 330	24 910	20 210	16 160	12 680	9 720	7 190	5 040	2 491,-	
	H1501CS	45			35 510	29 280	23 850	19 130	15 060	11 570	8 590	6 040	2 784,-	
	H2001CC	45	51 540	43 200	35 870	29 470	23 910	19 130	15 030	11 530	8 570	6 050	2 915,-	
	H1601CS	45			39 990	32 920	26 760	21 430	16 840	12 920	9 600	6 790	3 149,-	
	H2201CC	45	58 120	48 710	40 430	33 200	26 930	21 530	16 900	12 960	9 610	6 770	3 221,-	

Séria	Model	Kond. teplota [°C]	Chladiaci výkon Q [W] - R404A										Cena bez DPH Eur
			Odparovacia teplota										
			5	0	-5	-10	-15	-20	-25	-30	-35	-40	
H5	H2000CS	45			45 790	37 560	30 390	24 180	18 840	14 280	10 390	7 090	3 884,-
	H2500CC	45	66 130	55 230	45 640	37 260	29 980	23 700	18 300	13 690	9 760	6 390	3 955,-
	H2500CS	45			51 450	42 090	33 950	26 920	20 900	15 780	11 470	7 870	4 023,-
	H3000CC	45	74 410	62 040	51 170	41 680	33 440	26 360	20 300	15 160	10 810	7 150	4 164,-
	H2700CS	45			55 400	45 260	36 450	28 840	22 340	16 840	12 210	8 360	4 300,-
	H3200CC	45	80 050	66 790	55 110	44 910	36 040	28 390	21 820	16 200	11 410	7 320	4 438,-
	H2900CS	45			61 060	50 030	40 410	32 080	24 920	18 790	13 580	9 160	4 438,-
H6	H3400CC	45	88 960	74 110	61 050	49 650	39 760	31 240	23 970	17 800	12 600	8 220	4 578,-
	H3000CS	45			66 470	54 570	44 200	35 200	27 460	20 840	15 200	10 410	5 273,-
	H3500CC	45	95 430	79 860	66 160	54 210	43 840	34 910	27 280	20 780	15 280	10 620	5 410,-
	H3500CS	45			73 880	60 520	48 880	38 820	30 200	22 870	16 680	11 500	5 410,-
	H4000CC	45	106 700	89 350	74 140	60 860	49 310	39 350	30 800	23 480	17 230	11 870	5 619,-
	H4000CS	45			80 680	66 420	54 010	43 280	34 090	26 260	19 650	14 090	5 897,-
	H4500CC	45	116 300	97 220	80 500	65 900	53 270	42 420	33 160	25 320	18 720	13 180	6 105,-
H7	H4500CS	45			88 140	72 650	59 140	47 450	37 390	28 780	21 460	15 230	6 105,-
	H5000CC	45	128 900	107 700	89 040	72 810	58 770	46 720	36 470	27 820	20 570	14 510	6 242,-
	H5000CS	45			97 070	79 880	64 900	51 960	40 850	31 380	23 370	16 610	7 976,-
	H5500CC	45	144 900	120 800	99 590	81 240	65 430	51 910	40 440	30 770	22 670	15 870	8 185,-
	H5500CS	45			108 700	89 460	72 730	58 260	45 810	35 190	26 180	18 570	8 185,-
	H6000CC	45	162 700	135 600	111 900	91 280	73 550	58 390	45 520	34 660	25 540	17 880	8 531,-
	H6000CS	45			117 900	97 010	78 830	63 110	49 620	38 130	28 390	20 190	8 531,-
H7	H7500CC	45	176 100	146 800	121 100	98 760	79 550	63 120	49 170	37 410	27 550	19 290	9 016,-
	H7501CS	45			131 500	108 200	87 860	70 300	55 230	42 390	31 530	22 390	9 016,-
	H8001CC	45	196 200	163 800	135 300	110 500	88 930	70 510	54 860	41 680	30 670	21 530	9 642,-
	H8000CS	45			145 400	119 500	96 890	77 440	60 790	46 660	34 760	24 810	9 642,-
	H9000CC	45	215 000	179 200	147 800	120 600	97 120	77 050	60 030	45 670	33 630	23 550	10 982,-

So základným motorom, s elektronickou ochranou, H1-H2 séria s termickou ochranou, H32-H7 séria s PTC elektronikou.  
H5-H7 séria s elektronickým diferenčným presostatom.



Klimatizačné kompresory LG



KLIMATIZAČNÉ KOMPRESORY

Chladivo	Typ	Výkon [BTU]	Chladiaci výkon [kW]	Kondenzátor [uF] 400VAC	Napájanie [V] 50Hz	Popis	Obj. číslo DTN	Cena v EUR bez DPH
R410A	GK094P	7 500	2,2	30	230V	rotačný	103.39.2000	
	GK113P	9 000	2,6	30	230V	rotačný	103.39.2005	163,-
	GK151P	12 400	3,6	35	230V	rotačný	103.39.2010	176,-
	GJ176P / GJS189P	14 500	4,3	40	230V	rotačný	103.39.2015	198,-
	GJ222P / GJS222P	18 000	5,2	50	230V	rotačný	103.39.2020	226,-
	GP270P / GVS265P	22 800	5,4	50	230V	rotačný	103.39.2025	275,-
	GP290P / GVH282P	24 000	7,0	50	230V	rotačný	103.39.2030	285,-
	AQA028P	23 500	6,9	-	230V	scroll	102.39.2000	410,-
	AQA036P	29 700	8,7	-	230V	scroll	102.39.2005	391,-
	AQA042P	35 500	10,4	-	230V	scroll	102.39.2010	430,-
	AQA028Y	23 500	6,9	-	380V	scroll	102.39.2015	
	AQA036Y	29 700	8,7	-	380V	scroll	102.39.2020	
	AQA042Y	35 500	10,4	-	380V	scroll	102.39.2025	
	ARA049Y	41 500	12,2	-	380V	scroll	102.39.2030	513,-
	ARA053Y	45 000	13,2	-	380V	scroll	102.39.2035	
	ARA061Y	51 000	15,0	-	380V	scroll	102.39.2040	558,-
ARA073Y	61 000	17,9	-	380V	scroll	102.39.2045		
ARA081Y	68 300	20,0	-	380V	scroll	102.39.2050	670,-	

TOSHIBA GMCC

TOSHIBA GMCC klimatizačné kompresory



Chladivo	Typ	Menovitý Chladiaci výkon [BTU]	Menovitý Chladiaci výkon [kW]	Kondenzátor [uF/VAC]	Menovité napätie [V] 50Hz	Prevedenie	DTN obj. kód	Cena bez DPH
R410A	PA200X	16 800	4,96	45/400	230V	rotačný	103.56.2010	229,-

Kondenzátor nieje súčasťou dodávky.

SANYO Panasonic

SANYO klimatizačné kompresory



Chladivo	Typ	Menovitý Chladiaci výkon [BTU]	Menovitý Chladiaci výkon [kW]	Kondenzátor [uF] 400VAC	Menovité napätie [V] 50Hz	Prevedenie	DTN obj. kód	Cena bez DPH
R407C	C-SBS120H15A	33 080	9,70	60	230V	scroll	103.74.2000	505,-
	C-SBS145H15A	40 240	11,80	60	230V	scroll	103.74.2005	548,-
	C-SBS165H15A	46 000	13,50	70	230V	scroll	103.74.2010	575,-
	C-SBS180H15A	49 400	14,48	70	230V	scroll	103.74.2015	608,-
	C-SBS200H15H	55 240	16,20	80	230V	scroll	103.74.2020	724,-
	C-SBN263H8G	32 700	9,60	-	380V	scroll	103.74.2023	487,-
	C-SBN303H8G	39 560	11,60	-	380V	scroll	103.74.2025	544,-
	C-SBN353H8A	45 700	13,40	-	380V	scroll	103.74.2030	545,-
	C-SBN373H8G	49 450	14,50	-	380V	scroll	103.74.2035	578,-
	C-SBN453H8G	60 000	17,60	-	380V	scroll	103.74.2040	641,-
	C-SCN603H8K	83 550	24,50	-	380V	scroll	103.74.2045	1193,-
	C-SCN753H8K	102 000	29,90	-	380V	scroll	103.74.2055	1228,-
	C-SCN903H8K	119 000	34,90	-	380V	scroll	103.74.2060	1311,-
R410A HI-COP MODELY	C-SBN263H38B	30 180	8,85	-	380V	scroll	102.74.3000	487,-
	C-SBP120H38B	34 100	10,00	-	380V	scroll	102.74.3005	501,-
	C-SBP140H38B	39 900	11,70	-	380V	scroll	102.74.3010	559,-
	C-SBP160H38B	45 000	13,20	-	380V	scroll	102.74.3015	558,-
	C-SBP170H38B	48 700	14,29	-	380V	scroll	102.74.3020	590,-
	C-SBP205H38B	57 600	16,90	-	380V	scroll	102.74.3025	671,50
	C-SBP235H38B	67 900	19,90	-	380V	scroll	102.74.3030	688,-
	C-SCP270H38B	76 400	22,40	-	380V	scroll	102.74.3035	1227,-
	C-SCP315H38B	88 660	26,00	-	380V	scroll	102.74.3040	1261,-
	C-SCP360H38B	101 600	29,80	-	380V	scroll	102.74.3045	1298,-
	C-SCP400H38B	111 850	32,80	-	380V	scroll	102.74.3050	1334,-
C-SCP435H38B	129 300	37,92	-	380V	scroll	102.74.3055	1576,-	
C-SCP510H38B	149 700	43,90	-	380V	scroll	102.74.3060	1789,-	

Kondenzátor nieje súčasťou dodávky.





### Klimatizačné kompresory L'UNITE TECUMSEH



Chladivo	Typ	Chladiaci výkon [W] / Odparovacia teplota [°C]		Napájanie [V] 50Hz	Popis	Obj. číslo DTN	Cena v EUR bez DPH
		10	7,2				
		W	W				
R407C	RK5480C	1 869	1 691	230V	rotačný	103.54.5100	270,-
	RK5490C	2 037	1 838	230V	rotačný	103.54.5105	274,-
	RK5510C	2 421	2 190	230V	rotačný	103.54.5110	280,-
	RK5512W	2 671	2 415	230V	rotačný	103.54.5135	278,-
	RK5513W	2 936	2 660	230V	rotačný	103.54.5120	283,-
	RK5515W	3 579	3 240	230V	rotačný	103.54.5145	302,-
	RK5518W	4 095	3 710	230V	rotačný	103.54.5130	314,-

Kompresory neobsahujú spúšťacie kondenzátory v štandardnej dodávke.



### QX klimatizačné kompresory

Chladivo	Typ	Chladiaci výkon [kW]	Kondenzátor [uF] 450VAC	Napájanie [V] 50Hz	Popis	Obj. číslo DTN	Cena v EUR bez DPH
R22	QXR-13E 2FN1	2,10	25	230V	rotačný	103.40.1020	96,-
	QXR-15E 2FN1	2,50	25	230V	rotačný	103.40.1025	99,-
	QXR-21E 4DN3	3,60	30	230V	rotačný	103.40.1030	135,-
	QXR-29E 4DN2	4,86	35	230V	rotačný	103.40.1035	165,-
	QXR-33E5 DS1	5,60	50	230V	rotačný	103.40.1040	201,-
R407C	QXC-13K 2FN1	2,05	25	230V	rotačný	103.40.1000	99,-
	QXC-16K 2FN1	2,67	25	230V	rotačný	103.40.1005	105,-
	QXC-21K 4DN1	3,58	30	230V	rotačný	103.40.1010	145,-
	QXC-30K 4DN1	4,78	35	230V	rotačný	103.40.1015	172,-
	QXC-33K 4DN2	5,60	50	230V	rotačný	103.40.1016	230,-
	QXC-41K 4DN3	6,98	50	230V	rotačný	103.40.1017	232,-

Kompresory neobsahujú spúšťacie kondenzátory v štandardnej dodávke.

# HIGHLY

### HIGHLY kompaktné klimatizačné kompresory pre rozvádzače

R134a



Chladivo	Typ	Menovitý Chladiaci výkon [BTU]	Menovitý Chladiaci výkon [W]	Kondenzátor [uF] 400VAC	Menovité napätie [V] 50Hz	Prevedenie	DTN obj. kód	
R134a	BSA 357 CV	1 245	365	4,7/450V	230V	rotačný	103.73.3000	139,-
	BSA 645 CV	2 360	692	6,5/450V	230V	rotačný	103.73.3005	155,-

Kondenzátor nieje súčasťou dodávky.

## Nomenklatúry kompresorov:

# embraco

Séria kompresorov: [NB, NE, NJ, NT, EM...]

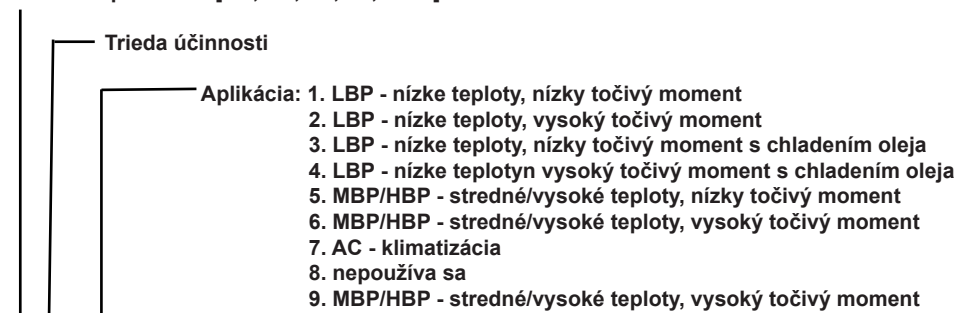

NEK 6 215 Z

Chladiaci výkon: Prvé číslo označuje počet núl, ktoré je potrebné za druhé dve číslice k získaniu približnej hodnoty chladiaceho výkonu v kcal/h pri 50 Hz.  
Príklad: 144 = 440 kcal/h pri 50 Hz.

Chladivo: A-B-C-D - miešané; CD - R744; E-F-G - R22; GE-GF-GG - R407C; GK-GJ - R404A/R507; GS - R404A/R507, 3 fázy; GP - R407C, 3 fázy; K-J-L - R502; M-N - miešané, 3 fázy; P - R22, 3 fázy, R - odsávanie chladív; S-T - R502, 3 fázy; U - UH - R290; V - R290 + R600; W-WW - vzduchový kompresor; X - R1270; Y - R600; Z-ZH-H - R134a; ZX - R134a 3 fázy

# Agregáty



AGREGÁTY

**COPELAND agregáty**

R404A/R507



Typ	Okolité teplota °C	Chladiaci výkon [kW] Odparovacia teplota [°C]											Prípoje [zoll]		Príkon to=-10°C [kW]	Objem maziva [L]	Menovité napätie 50Hz [V]	Max. prúd [A]	DTN obj. kód	
		-40	-35	-30	-25	-20	-15	-10	-5	0	5	7	10	Sanie						Výtlak
MC-B8-ZF06KE	32	1,07	1,32	1,59	1,88	2,19	2,52	2,85	3,2					3/4"	1/2"	2,43	3,1	380V	5,5	122.04.9020
MC-D8-ZF09KE	32	1,52	1,89	2,31	2,76	3,25	3,8	4,35	5	5,65	6,3	6,6		7/8"	1/2"	2,59	3,7	380V	6,0	122.04.9025
MC-H8-ZF09KE	32	1,59	1,99	2,45	2,95	3,55	4,2	4,9	5,70	6,55	7,5	7,85		7/8"	1/2"	2,47	7,5	380V	6,0	122.04.9030
MC-H8-ZF11KE	32	1,98	2,47	3	3,6	4,3	5	5,85	6,75	7,70	8,75	9,15		7/8"	1/2"	3,07	7,5	380V	7,0	122.04.9035
MC-H8-ZF13KE	32	2,2	2,76	3,4	4,1	4,85	5,70	6,6	7,55	8,6	9,70	10,1		7/8"	1/2"	3,51	7,5	380V	8,0	122.04.9040
MC-M8-ZF13KE	32	2,25	2,83	3,5	4,25	5,1	6	7	8,1	9,3	10,55	11,05		7/8"	1/2"	3,33	7,5	380V	8,0	122.04.9045
MC-H8-ZF15KE	32	2,66	3,3	4	4,8	5,65	6,55	7,5	8,5	9,55	10,55			7/8"	1/2"	4,64	7,5	380V	10,0	122.04.9050
MC-M8-ZF15KE	32	2,74	3,4	4,15	5,05	6	7	8,1	9,3	10,55	11,85	12,35		7/8"	1/2"	4,34	7,5	380V	10,0	122.04.9055
MC-M8-ZF18KE	32	3,3	4,05	4,95	5,9	6,95	8,1	9,3	10,6	11,95	13,35	13,9		7/8"	1/2"	5,15	7,5	380V	12,0	122.04.9060
MC-M9-ZF18KE	32	3,35	4,2	5,1	6,15	7,3	8,6	9,95	11,45	13	14,65	15,3		7/8"	1/2"	5,05	7,5	380V	12,0	122.04.9006
MC-P8-ZF24KE	32	3,85	4,85	5,9	7	8,15	9,4	10,65	12	13,45				1-3/8"	1/2"	7,2	7,5	380V	16,1*	122.04.9065
MC-S9-ZF24KE	32	4,15	5,25	6,45	7,8	9,25	10,9	12,70	14,70	16,8	19,1	20,1		1-3/8"	1/2"	6,5	11,5	380V	16,1*	122.04.9016
MC-R7-ZF33KE	32	5,45	6,75	8,2	9,8	11,5	13,3	15,3	17,3	19,4				1-3/8"	5/8"	9,65	11,5	380V	22,3*	122.04.9070
MC-V9-ZF33KE	32	5,70	7,15	8,75	10,55	12,55	14,75	17,1	19,70	22,5	25,5	26,70		1-3/8"	5/8"	8,85	11,5	380V	22,3*	122.04.9013
MC-S9-ZF40KE	32	6,65	8,35	10,15	12,1	14,1	16,3	18,6	21	23,6				1-3/8"	5/8"	12	11,5	380V	25,1*	122.04.9075
MC-V6-ZF40KE	32	7,05	8,95	11	13,3	15,8	18,6	21,70	25	28,70	32,5	34		1-3/8"	5/8"	11	11,5	380V	25,1*	122.04.9010
MC-S9-ZF48KE	32	7,85	9,6	11,55	13,70	15,9	18,2	20,6						1-3/8"	5/8"	16,6	11,5	380V	30,6*	122.04.9075

**COPELAND agregáty**

R404A/R507



Typ	Okolité teplota °C	Chladiaci výkon [kW] Odparovacia teplota [°C]											Prípoje [zoll]		Príkon to=-10°C [kW]	Objem maziva [L]	Menovité napätie 50Hz [V]	Max. prúd [A]	DTN obj. kód		
		-40	-35	-30	-25	-20	-15	-10	-5	0	5	7	10	Sanie						Výtlak	
MC-D8-ZB15KE	32			1,18	1,79	2,24	2,73	3,25	3,8	4,4	5	5,3	5,65	3/4"	1/2"	2	3,7	230V	12,8	122.04.9080	
MC-H8-ZB15KE	32			1,52	1,97	2,46	3	3,6	4,3	5	5,8	6,15	6,65	3/4"	1/2"	1,86	3,7	230V	12,8	122.04.9085	
MC-D8-ZB19KE	32			1,66	2,33	2,79	3,3	3,85	4,5	5,15	5,85	6,15	6,6	3/4"	1/2"	2,42	3,7	230V	12,8	122.04.9090	
MC-H8-ZB19KE	32			2,05	2,52	3,05	3,65	4,35	5,1	5,9	6,8	7,2	7,8	3/4"	1/2"	2,22	7,5	230V	12,8	122.04.9095	
MC-K9-ZB19KE	32			2,05	2,53	3,05	3,65	4,35	5,1	5,95	6,85	7,25	7,85	3/4"	1/2"	2,24	3,7	230V	12,8	122.04.9100	
MC-D8-ZB21KE	32			1,9	2,68	3,2	3,75	4,4	5	5,70	6,35	6,65		7/8"	1/2"	3,09	7,5	230V	16,4	122.04.9105	
MC-H8-ZB21KE	32			2,4	2,95	3,6	4,3	5,05	5,9	6,8	7,8	8,2	8,8	7/8"	1/2"	2,74	7,5	230V	16,4	122.04.9110	
MC-K9-ZB21KE	32			2,4	2,95	3,6	4,3	5,1	5,95	6,85	7,85	8,25	8,85	7/8"	1/2"	2,75	3,7	230V	16,4	122.04.9002	
MC-H8-ZB26KE	32			2,4	3,35	4,05	4,8	5,65	6,55	7,55	8,65	9,1	9,8	7/8"	1/2"	3,3	7,5	230V	18,0	122.04.9115	
MC-K9-ZB26KE	32			2,41	3,35	4,05	4,85	5,70	6,6	7,6	8,70	9,15	9,85	7/8"	1/2"	3,31	7,5	230V	18,0	122.04.9003	
MC-H8-ZB30KE	32	1,62	2,11	2,68	3,8	4,55	5,4	6,35	7,35	8,45	9,6	10,05	10,8	7/8"	1/2"	3,91	7,5	380V	10,3	122.04.9120	
MC-M8-ZB30KE	32	1,69	2,21	3,25	3,95	4,8	5,75	6,8	7,95	9,2	10,5	11,05	11,95	7/8"	1/2"	3,63	7,5	380V	10,3	122.04.9125	
MC-P8-ZB30KE	32	1,71	2,23	3,25	4	4,85	5,8	6,9	8,05	9,3	10,70	11,25	12,15	7/8"	1/2"	3,6	7,5	380V	10,3	122.04.9130	
MC-H8-ZB38KE	32		2,52	3,2	4,45	5,35	6,3	7,3	8,4	9,5	10,70			7/8"	1/2"	5,2	7,5	380V	12,8	122.04.9135	
MC-M8-ZB38KE	32	2,05	2,67	3,4	4,75	5,70	6,8	7,95	9,25	10,6	12	12,6	13,55	7/8"	1/2"	4,78	7,5	380V	12,8	122.04.9004	
MC-P8-ZB38KE	32	2,07	2,70	3,45	4,8	5,8	6,9	8,1	9,4	10,8	12,3	12,9	13,85	7/8"	1/2"	4,73	7,5	380V	12,8	122.04.9007	
MC-M8-ZB42KE	32			3,70	5,25	6,3	7,45	8,65	9,95	11,3	12,75	13,3	14,2	7/8"	1/2"	5,55	7,5	230V	29,8	122.04.9140	
MC-R7-ZB42KE	32			4,6	5,70	6,9	8,25	9,75	11,4	13,2	15,1	15,9	17,1	7/8"	1/2"	5,1	7,5	230V	29,8	122.04.9145	
MC-M8-ZB45KE	32		3,05	3,85	5,4	6,5	7,65	8,9	10,25	11,65	13,15	13,75		7/8"	1/2"	5,70	7,5	380V	13,1	122.04.9150	
MC-M9-ZB45KE	32	2,42	3,15	4,05	5,70	6,85	8,15	9,6	11,1	12,75	14,5	15,2	16,3	7/8"	1/2"	5,5	7,5	380V	13,1	122.04.9005	
MC-R7-ZB45KE	32	2,5	3,3	4,8	5,9	7,15	8,55	10,1	11,75	13,6	15,5	16,4	17,6	7/8"	1/2"	5,25	7,5	380V	13,1	122.04.9008	
MC-R7-ZB58KE	32			4,8	6,75	8,15	9,6	11,25	13	14,9	19,6	17,70	19	1-3/8"	1-3/8"	7	7,5	380V	15,4	122.04.9155	
MC-S9-ZB58KE	32			5,70	7	8,45	10,05	11,8	13,75	15,8	18,1	19,1	20,5	1-3/8"	1-3/8"	6,65	11,5	380V	15,4	122.04.9160	
MC-V9-ZB76KE	32			8,2	10	12	14,2	16,6	19,2	22	24,9	26,1	28	1-3/8"	1-3/8"	8,75	14,0	380V	21,7	122.04.9165	
MC-V6-ZB76KE	32			8,5	10,5	12,65	15,1	17,8	20,8	24,1	27,6	29,1	31,5	1-3/8"	1-3/8"	8,5	14,0	380V	21,7	122.04.9170	
MC-V9-ZB95KE	32				11,95	14,2	16,6	19,3	22,1	25	28,1	29,4	31,5	1-3/8"	1-3/8"	11,70	14,0	380V	25,1	122.04.9175	
MC-V6-ZB95KE	32				10,4	12,70	15,2	18	21,1	24,5	28,1	32	33,5	36	1-3/8"	1-3/8"	11,1	14,0	380V	25,1	122.04.9180
MC-V6-ZB114KE	32				10,55	14,75	17,8	21	24,6	28,4	32,5	37	39	41,5	1-3/8"	1-3/8"	13,8	14,0	380V	29,2	122.04.9185
MC-W9-ZB114KE	32				10,65	14,9	17,9	21,2	24,8	28,8	33	37,5	39,5	42,5	1-5/8"	1-5/8"	13,70	14,0	380V	29,2	122.04.9190

S rotalock ventilmi, elektronickými ochrannými zariadeniami, s náplňou oleja. Verzie ZF s príslušenstvom na vstrekovanie chladiča.

## Kondenzačné jednotky R404A

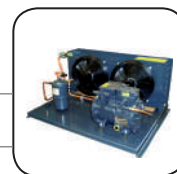

Typ	Okolité teplota	Výkon pri odparovacej teplote Q [W]										Cena bez DPH
		5	0	-5	-10	-15	-20	-25	-30	-35	-40	
	[°C]	[W]										Eur
AU-H80CC	32		3180	2720	2300	1920	1580	1280	1010	775	575	1 514
AU-H80CS	32					2370	1970	1600	1270	980	735	1 514
AU-H101CC	32			3330	2830	2370	1940	1560	1230	935	680	1 518
AU2-H101CC	32		4200	3580	3010	2490	2030	1620	1270	960	700	1 738
AU-H101CS	32					2720	2270	1850	1480	1150	855	1 518
AU2-H101CS	32				3470	2910	2400	1940	1540	1180	880	1 738
AU-H151CC	32			3990	3400	2850	2350	1900	1500	1150	850	1 571
AU2-H151CC	32			4130	3510	2930	2410	1940	1530	1170	860	1 748
AU-H151CS	32				3700	3130	2590	2120	1690	1310	975	1 571
AU2-H151CS	32				3820	3210	2660	2160	1720	1330	985	1 748
AU-H181CC	32	6310	5450	4660	3930	3270	2690	2160	1710	1320	985	1 620
AU2-H181CC	32	6370	5500	4700	3960	3290	2700	2180	1720	1320	990	1 803
AU-H181CS	32			5450	4660	3920	3240	2630	2090	1610	1210	1 620
AU2-H181CS	32			5510	4700	3950	3260	2650	2100	1620	1210	1 803
AU-H201CC	32	7180	6260	5420	4630	3910	3250	2650	2110	1610	1150	1 664
AU2-H201CC	32	7280	6340	5470	4670	3940	3270	2670	2120	1620	1160	1 847
AU-H201CS	32				4930	4160	3450	2810	2230	1730	1280	1 664
AU2-H201CS	32				4980	4200	3470	2830	2250	1730	1290	1 847
AU-H221CC	32	7600	6650	5750	4920	4130	3410	2760	2180	1670	1230	1 696
AU2-H221CC	32	7710	6740	5820	4970	4170	3440	2780	2190	1680	1230	1 876
AU-H221CS	32			6120	5250	4430	3680	2990	2380	1840	1380	1 696
AU2-H221CS	32			6810	5760	4800	3940	3180	2510	1920	1430	2 103
AU-H251CC	32	9350	8080	6900	5810	4830	3950	3180	2500	1910	1420	2 027
AU2-H251CC	32	9060	7850	6730	5700	4740	3900	3140	2470	1900	1400	2 103
AU-H251CS	32				5680	4820	4010	3270	2600	2000	1480	1 738
AU2-H251CS	32			7410	6290	5250	4320	3480	2750	2100	1550	2 146
AU-H281CC	32	10260	8840	7540	6330	5260	4300	3440	2690	2040	1480	2 070
AU2-H281CC	32	9940	8600	7340	6200	5160	4230	3390	2660	2020	1470	2 146
AU-H281CS	32			8220	6950	5790	4740	3810	2990	2280	1670	2 146
AU2-H281CS	32			7990	6770	5670	4650	3750	2950	2250	1650	2 183
AU-H290CS	32			9050	7710	6450	5320	4320	3430	2650	1980	2 203
AU2-H290CS	32			8770	7490	6310	5220	4240	3370	2610	1960	2 271
AU-H300CC	32	13540	11610	9840	8250	6820	5560	4450	3480	2650	1950	2 501
AU2-H300CC	32	12860	11100	9470	7970	6620	5420	4350	3420	2610	1920	2 586
AU-H300CS	32				8170	6880	5700	4640	3700	2890	2180	2 229
AU2-H300CS	32				7930	6700	5580	4550	3650	2850	2160	2 303
AU-H350CC	32	14360	12370	10530	8860	7390	6060	4890	3870	3000	2260	2 501
AU2-H351CC	32	13620	11790	10110	8570	7150	5900	4780	3800	2950	2220	2 586
AU-H380CC	32		13360	11440	9650	8080	6660	5410	4310	3360	2540	2 692
AU2-H381CC	32		12670	10910	9290	7810	6460	5270	4220	3300	2500	2 778
AU-H390CS	32				9590	8180	6870	5660	4590	3630	2800	2 421
AU2-H390CS	32				9240	7920	6680	5550	4500	3580	2770	2 495
AU-H392CS	32							6400	5120	3990	2990	2 474
AU2-H392CS	32							6640	5290	4100	3060	2 831
AU-H355CS	32			11420	9730	8150	6720	5420	4270	3280	2440	3 128
AU2-H355CS	32			12070	10200	8500	6950	5590	4390	3350	2480	3 384

Kondenzačné jednotky R404A

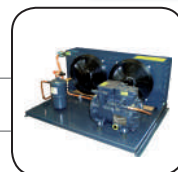

Typ	Okolité teplota	Výkon pri odparovacej teplote Q [W]										Cena bez DPH
		5	0	-5	-10	-15	-20	-25	-30	-35	-40	
	[°C]	[W]										Eur
AU-H405CC	32	17700	15140	12800	10660	8750	7070	5600	4340	3280	2410	3 162
AU2-H405CC	32	16570	14280	12150	10200	8430	6840	5450	4240	3220	2370	3 418
AU-H405CS	32			12940	11110	9410	7810	6350	5020	3860	2860	2 890
AU2-H405CS	32			13820	11780	9880	8150	6570	5170	3960	2920	3 136
AU-H505CC	32	20130	17350	14780	12400	10240	8310	6610	5150	3890	2850	3 196
AU2-H505CC	32	18630	16180	13880	11750	9780	8010	6400	5000	3800	2790	3 459
AU-H505CS	32			16570	14090	11790	9680	7810	6160	4720	3500	3 222
AU2-H505CS	32			15490	13280	11200	9300	7530	5970	4600	3420	3 491
AU2-H705CC	32	20560	17990	15550	13280	11160	9220	7420	5850	4470	3300	3 536
AU-H705CS	32			18510	15810	13310	11010	8920	7060	5440	4060	3 330
AU2-H705CS	32			17150	14780	12570	10480	8570	6820	5290	3960	3 536
AU2-H755CC	32	28390	24460	20820	17490	14440	11750	9360	7300	5530	4060	3 912
AU2-H751CS	32			21050	18080	15290	12710	10310	8170	6270	4630	3 818
AU2-H1002CC	32	31610	27290	23260	19590	16220	13190	10520	8210	6230	4560	4 198
AU2-H851CS	32			26420	22570	19000	15700	12720	10090	7790	5800	4 365
AU2-H1201CC	32	39320	33870	28870	24300	20180	16510	13260	10410	7950	5860	4 981
AU2-H1001CS	32			29150	25080	21260	17740	14470	11570	9000	6770	4 526
AU2-H1501CC	32	42980	37260	31940	27080	22610	18620	15040	11920	9170	6820	5 109
AU2-H1501CS	32			32280	27950	23820	19960	16410	13140	10230	7690	4 908
AU2-H2001CC	32	48720	42420	36510	31030	26030	21480	17420	13830	10710	8000	5 535
AU2-H1601CS	32			39490	33820	28530	23680	19250	15330	11890	8900	5 768
AU4-H2201CC	32	56490	48940	42010	35600	29790	24490	19840	15730	12140	9060	7 107
AU2-H2000CS	32			43350	37220	31480	26100	21150	16710	12750	9290	6 617
AU4-H2500CC	32	61850	53700	46170	39100	32620	26670	21350	16630	12480	8890	7 892
AU4-H2500CS	32			50100	42800	35890	29600	23830	18720	14220	10330	8 035
AU4-H3000CC	32	70500	61100	52330	44210	36770	29970	23910	18590	13940	9940	8 629
AU4-H2700CS	32			55330	46990	39290	32160	25850	20230	15330	11130	8 771
AU4-H3200CC	32	74230	64500	55350	46900	39100	31920	25510	19770	14740	10380	8 916
AU4-H2900CS	32			59400	50770	42680	35200	28340	22230	16830	12100	8 916
AU4-H3000CS	32			66440	56620	47590	39220	31760	25080	19250	14180	10 973
AU4-H3500CC	32	88710	77170	66410	56480	47360	38970	31520	24920	19150	14170	11 105
AU4-H3500CS	32			71650	61240	51490	42560	34410	27190	20860	15380	11 105
AU4-H4000CC	32	95570	83590	72300	61820	52030	43120	34940	27720	21330	15760	11 299

Kondenzačné jednotky sa dodávajú bez príslušenstva (ohrev oleja, vykáblovanie, atď).

# embraco

**Embraco agregáty výsuvné - NOVINKA !**

Chladiace R404A/R507

Typ	Okolité teplota	Napájanie	Pripoje [zoll]		Výkon EN13215 To= -10°C [W]	Akustický tlak pri 10 m [dB(A)]	Akustický výkon [dB(A)]	DTN obj. kód	Cena bez DPH
	°C		Sanie	Výtlač					
UDNEK6210GK	32	220-240V/50Hz	3/8"	1/4"	704	31,9	59,9	121.25.2000	909,-
UDNEK6213GK	32	220-240V/50Hz	3/8"	1/4"	907	32,2	60,2	121.25.2005	939,-
UDNEK6217GK	32	220-240V/50Hz	1/2"	3/8"	1184	33,8	61,8	121.25.2010	969,-
UDNT6222GK	32	220-240V/50Hz	1/2"	3/8"	1470	34	62	121.25.2015	1050,-
UDNT6226GK	32	220-240V/50Hz	1/2"	3/8"	1614	35,1	63,1	121.25.2020	1091,-
UDNJ9232GK	32	220-240V/50Hz	1/2"	3/8"	2115	40	68	121.25.2025	1172,-
UDNJ9238GK	32	220-240V/50Hz	1/2"	3/8"	2422	40,7	68,7	121.25.2030	1232,-



Mraziace R404A/R507

**Embraco agregáty výsuvné**

Typ	Okolité teplota	Napájanie	Pripoje [zoll]		Výkon EN13215 To= -25°C [W]	Akustický tlak pri 10 m [dB(A)]	Akustický výkon [dB(A)]	DTN obj. kód	Cena bez DPH
	°C		Sanie	Výtlač					
UDNEK2150GK	32	220-240V/50Hz	3/8"	1/4"	497	31,5	59,5	121.25.2100	869,-
UDNEK2168GK	32	220-240V/50Hz	3/8"	1/4"	614	31,6	59,6	121.25.2105	909,-
UDNT2180GK	32	220-240V/50Hz	1/2"	3/8"	813	32,9	60,9	121.25.2110	990,-
UDNT2192GK	32	220-240V/50Hz	1/2"	3/8"	919	33,1	61,1	121.25.2115	1050,-
UDNT2212GK	32	220-240V/50Hz	1/2"	3/8"	1134	33,1	61,1	121.25.2120	1091,-
UDNJ2212GK	32	220-240V/50Hz	1/2"	3/8"	1339	36,3	64,3	121.25.2125	1192,-

**Vonkajšie rozmery**

A	B	C	D	E	F
822	470	460	600	436	10,5

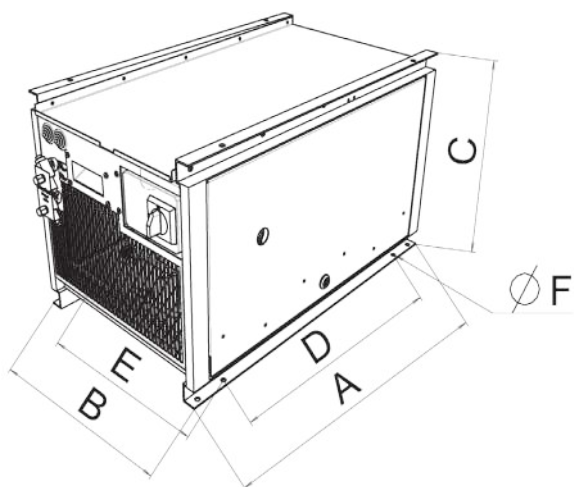

EMBRACO

**Estetické - Energeticky efektívne - Šetria priestor - Stohovateľné - Šetria čas montáže - Vysoká kvalita - Jednoduchá servisovateľnosť**

**embraco**

EMBRACO agregáty



R404A/R507

Model	Okolité teplota °C	Chladiaci výkon [W] Odparovacia teplota [°C]							Pripojenie		Príkion pri to=-23,3°C [W]	Objem zásobníka [L]	Napájanie 50Hz [V]	max. el. prúd [A]	Obj. číslo DTN	Cena bez DPH
		-40	-35	-30	-23,3	-20	-15	-10	Sanie	Výtlak						
UNEK2125GK	32	194	236	322	410	451	529	644	3/8"	1/4"	342	1,1	230V	2,48	121.25.1010	261 €
UNEK2134GK	32	227	267	381	490	552	649	756	3/8"	1/4"	342	1,1	230V	2,77	121.25.1015	270 €
UNEK2150GK	32	341	398	474	639	683	817	969	3/8"	1/4"	530	1,1	230V	3,52	121.25.1020	281 €
UNEK2168GK	32	330	453	585	840	957	1 120	1 270	1/2"	1/4"	730	1,1	230V	4,17	121.25.1025	312 €
UNT2178GK	32	393	507	655	910	1 058	1 312	1 602	3/8"	1/4"	655	1,2	230V	4,39	121.25.1050	355 €
UNT2192GK	32	498	647	835	1 146	1 325	1 627	1 968	1/2"	3/8"	842	2,3	230V	5,50	121.25.1055	378 €
UNT2212GK	32	650	827	1 056	1 443	1 668	2 051	2 486	1/2"	3/8"	991	2,3	230V	5,84	121.25.1056	417 €
UNJ2192GK	32	453	612	795	1 198	1 373	1 687	2 030	1/2"	3/8"	942	2,3	230V	4,75	121.25.1060	456 €
UNJ2192GS	32	453	612	795	1 081	1 233	1 488	1 767	1/2"	3/8"	900	2,3	380V	2,28	121.25.1065	464 €
UNJ2212GK	32	616	886	1 163	1 599	1 826	2 198	2 605	5/8"	3/8"	1 175	2,3	230V	6,05	121.25.1070	483 €
UNJ2212GS	32	616	886	1 163	1 599	1 826	2 198	2 605	5/8"	3/8"	1 479	2,3	380V	2,38	121.25.1075	510 €

**embraco**

EMBRACO agregáty



R404A/R507

Model	Okolité teplota °C	Chladiaci výkon [W] Odparovacia teplota [°C]							Pripojenie		Príkion pri to=-23,3°C [W]	Objem zásobníka [L]	Napájanie 50Hz [V]	max. el. prúd [A]	Obj. číslo DTN	Cena bez DPH
		-20	-15	-10	-5	0	7,2	10	Sanie	Výtlak						
UNEK6144GK	35	240	298	359	423	490	600	640	3/8"	1/4"	380	0,6	230V	2,02	121.25.1225	240 €
UNEK6165GK	35	382	429	504	588	660	805	867	3/8"	1/4"	471	1,1	230V	2,79	121.25.1230	250 €
UNEK6181GK	35	427	530	644	767	900	1 252	1 130	3/8"	1/4"	620	1,1	230V	2,70	121.25.1235	273 €
UNEK6210GK	35	581	670	665	886	1 032	1 302	1 428	3/8"	1/4"	628	1,1	230V	3,91	121.25.1240	272 €
UNEK6213GK	35	734	904	1 064	1 213	1 352	1 531	1 787	3/8"	1/4"	1 074	1,1	230V	5,97	121.25.1245	287 €
UNEK6217GK	35	741	960	1 180	1 406	1 640	1 985	2 058	1/2"	3/8"	1 136	2,3	230V	5,55	121.25.1250	353 €
UNT6217GK	35	748	955	1 144	1 398	1 635	1 994	2 137	1/2"	3/8"		2,3	230V	5,47	121.25.1266	376 €
UNT6220GK	35	793	1 024	1 262	1 506	1 754	2 124	2 268	1/2"	3/8"	1 095	2,3	230V	5,85	121.25.1270	404 €
UNT6222GK	35	1 105	1 370	1 636	1 899	2 162	2 540	2 686	1/2"	3/8"		2,3	230V	6,35	121.25.1271	417 €
UNT6226GK	35	1 266	1 568	1 878	2 198	2 526	3 016	3 210	1/2"	3/8"	1 500	2,3	230V	7,27	121.25.1275	450 €
UNJ9226GK	35	1 215	1 537	1 873	2 223	2 588	3 141	3 360	5/8"	3/8"	1 403	2,3	230V	6,70	121.25.1280	484 €
UNJ9226GS	35	1 206	1 523	1 822	2 094	2 364	2 720	2 831	5/8"	3/8"	1 300	2,3	380V	2,78	121.25.1285	507 €
UNJ9232GK	35	1 412	1 764	2 124	2 512	2 898	3 474	3 696	5/8"	1/2"	1 728	3,9	230V	8,12	121.25.1290	511 €
UNJ9232GS	35	1 467	1 855	2 219	2 550	2 879	3 365	3 448	5/8"	1/2"	1 685	3,9	380V	3,35	121.25.1295	542 €
UNJ9238GK	35	1 748	2 147	2 560	3 157	3 434	4 104	4 372	5/8"	1/2"	2 321	3,9	230V	10,01	121.25.1300	540 €
UNJ9238GS	35	1 872	2 268	2 685	3 134	3 638	4 419	4 737	5/8"	1/2"	2 332	3,9	380V	4,49	121.25.1305	571 €

Kondenzačné jednotky sú dodávané individuálne zabalené, so zásobníkom chladiva, s rotalock ventilmi a zapojeným elektro príslušenstvom.





## L'UNITE Tecumseh agregáty - LBP



R404A/R507

Typ	Okolité teplota °C	Chladiaci výkon [W] Odparovacia teplota [°C] EN13215 RTG 20°C							Prípoje [zoll]		Prietok vzduchu [m³/h]	Menovité napätie 50Hz [V]	Max. prúd [A]	DTN obj. kód	Cena bez DPH
		-40	-35	-30	-23,3	-20	-15	-10	Sanie	Výtlak					
CAJ2432ZBR	32	271	380	506	695	796	957	1 125	1/2"	1/4"	550	230V	5,60	121.54.1030	525,-
CAJ2446ZBR	32	480	664	869	1 174	1 334	1 586	1 843	1/2"	3/8"	900	230V	8,10	121.54.1040	602,-
TAJ2446ZBR	32	480	664	869	1 174	1 334	1 586	1 843	1/2"	3/8"	900	380V	3,10	121.54.1100	610,-
CAJ2464ZBR	32	631	838	1 070	1 414	1 593	1 873	2 157	5/8"	3/8"	900	230V	10,20	121.54.1045	604,-
TAJ2464ZBR	32	631	838	1 070	1 414	1 593	1 873	2 157	5/8"	3/8"	900	380V	3,50	121.54.1105	704,-
TFH2480ZBR	32	791	1 174	1 567	2 109	2 382	2 803	3 230	5/8"	3/8"	2 200	380V	5,20	121.54.1110	1126,-
TFH2511ZBR	32	1 086	1 560	2 086	2 859	3 260	3 885	4 516	5/8"	3/8"	2 250	380V	5,40	121.54.1115	1173,-
TAG2516ZBR	32	1 538	2 235	2 994	4 105	4 691	5 624	6 608	7/8"	3/8"	4 800	380V	7,10	121.54.1120	1823,-
TAG2522ZBR	32	2 028	2 869	3 779	5 102	5 796	6 896	8 050	1-1/8"	3/8"	4 800	380V	8,40	121.54.1125	1889,-



## L'UNITE Tecumseh agregáty - HBP



R404A/R507

Typ	Okolité teplota °C	Chladiaci výkon [W] Odparovacia teplota [°C] EN13215 RTG 20°C							Prípoje [zoll]		Prietok vzduchu [m³/h]	Menovité napätie 50Hz [V]	Max. prúd [A]	DTN obj. kód	Cena bez DPH
		-20	-15	-10	-5	0	7,2	10	Sanie	Výtlak					
AE4440ZHR	32		470	570	675	783	944	1 008	3/8"	1/4"	800	230V	4,40	121.54.1206	361,-
AE4450ZMHR	32		579	702	834	974	1 189	1 276	3/8"	1/4"	980	230V	4,80	121.54.1211	377,-
AE4460ZMHR	32	560	696	835	977	1 122	1 333	1 415	3/8"	1/4"	980	230V	4,70	121.54.1220	398,-
AE4470ZHR	32	723	890	1 067	1 251	1 442	1 728	1 841	3/8"	1/4"	1 130	230V	6,40	121.54.1225	402,-
CAJ9480ZMHR	32	817	1 015	1 229	1 459	1 701	2 064	2 208	1/2"	3/8"	900	230V	6,90	121.54.1230	585,-
CAJ9510ZMHR	32	999	1 221	1 457	1 704	1 960	2 333	2 477	5/8"	3/8"	900	230V	8,20	121.54.1235	620,-
TAJ9510ZMHR	32	999	1 221	1 457	1 704	1 960	2 333	2 477	5/8"	3/8"	900	380V	3,20	121.54.1305	632,-
CAJ9513ZMHR	32	1 065	1 348	1 642	1 941	2 239	2 648	2 798	5/8"	3/8"	900	230V	10,40	121.54.1240	671,-
TAJ9513ZMHR	32	1 065	1 348	1 642	1 941	2 239	2 648	2 798	5/8"	3/8"	900	380V	4,10	121.54.1310	678,-
CAJ4517ZHR	32		1 836	2 232	2 650	3 084	3 729	3 982	5/8"	3/8"	1 700	230V	13,20	121.54.1245	809,-
TAJ4517ZHR	32		1 836	2 232	2 650	3 084	3 729	3 982	5/8"	3/8"	1 700	380V	4,40	121.54.1315	831,-
CAJ4519ZHR	32		2 302	2 744	3 198	3 656	4 300	4 541	5/8"	3/8"	1 700	230V	15,70	121.54.1250	867,-
TAJ4519ZHR	32		2 302	2 744	3 198	3 656	4 300	4 541	5/8"	3/8"	1 700	380V	5,20	121.54.1320	893,-
FH4524ZHR	32		2 457	3 009	3 579	4 155	4 969	5 276	5/8"	3/8"	2 480	230V	18,90	121.54.1321	1185,-
TFH4524ZHR	32		2 457	3 009	3 579	4 155	4 969	5 276	5/8"	3/8"	2 480	380V	6,70	121.54.1330	1143,-
TFH4531ZHR	32		3 461	4 226	5 044	5 912	7 247	7 794	7/8"	1/2"	4 800	380V	9,00	121.54.1340	1499,-
TFH4540ZHR	32		4 523	5 477	6 481	7 524	9 073	9 685	7/8"	1/2"	4 800	380V	10,00	121.54.1350	1666,-
TAG4546ZHR	32		4 944	6 208	7 582	9 047	11 268	12 154	7/8"	5/8"	7 000	380V	12,30	121.54.1355	1911,-
TAG4553ZHR	32		5 416	6 725	8 128	9 605	11 817	12 963	7/8"	5/8"	7 000	380V	14,50	121.54.1360	2074,-
TAG4561ZHR	32		6 218	7 663	9 205	10 820	13 221	14 163	1-1/8"	5/8"	6 600	380V	15,10	121.54.1365	2363,-
TAG4568ZHR	32		7 466	9 125	10 911	12 804	15 675	16 826	1-1/8"	5/8"	6 000	380V	16,30	121.54.1370	2473,-
TAG4573ZHR	32		7 952	9 609	11 377	13 236	16 027	17 139	1-1/8"	5/8"	6 000	380V	20,00	121.54.1375	2568,-



Kondenzačná jednotka		Okolité teplota (°C)	Chladiaci výkon W						Dimensions (mm)			Hmot- nosť kg	Pripojenia		Cena bez DPH Eur
Model	Napájanie (V)		-35°C	-30°C	-25°C	-20°C	-15°C	-10°C	W (width)	D (Depth)	H (height)		Sanie (mm)	Kvapa- lina (mm)	
UP-NT2180GK	K: 230V-1~50Hz V: 230V-1~50Hz	25	562	729	931	1165	1425	1705	980	488	600	69	12	6	1 677,-
		32	492	640	818	1021	1246	1487							
		38	421	555	712	891	1087	1298							
		43	-	482	623	782	957	1143							
UP-NT2192GK	K: 230V-1~50Hz V: 230V-1~50Hz	25	607	787	995	1230	1490	1771	980	488	600	69	12	8	1 698,-
		32	527	684	867	1073	1302	1550							
		38	451	590	752	935	1139	1360							
		43	-	512	657	822	1005	1205							
UP-NT2212GK	K: 230V-1~50Hz V: 230V-1~50Hz	25	801	1032	1312	1637	2002	2402	980	488	600	69	16	8	1 735,-
		32	699	906	1155	1444	1767	2123							
		38	601	787	1010	1269	1559	1876							
		43	-	688	890	1123	1385	1672							
UP-NJX2219GS	K: 400V-3~50Hz V: 230V-1~50Hz	25	1214	1575	2010	2516	3086	3714	1080	488	708	88	16	8	2 142,-
		32	1074	1395	1782	2231	2737	3294							
		38	942	1229	1575	1976	2428	2926							
		43	825	1084	1397	1759	2167	2615							
UP-SE2006GK	K: 230V-1~50Hz V: 230V-1~50Hz	25	1300	1627	2017	2469	2984	3561	1080	488	708	92	18	10	2 358,-
		32	1169	1464	1815	2221	2684	3203							
		38	1040	1305	1620	1986	2403	2872							
		43	928	1166	1450	1781	2159	2585							
UP-SE2006GS	K: 400V-3~50Hz V: 230V-1~50Hz	25	1300	1628	2017	2470	2985	3562	1080	488	708	92	18	10	2 358,-
		32	1169	1465	1815	2222	2685	3204							
		38	1040	1306	1621	1987	2404	2873							
		43	928	1167	1451	1782	2160	2586							
UP-SE2008GK	K: 400V-3~50Hz V: 230V-1~50Hz	25	1633	2038	2516	3067	3689	4379	1080	488	708	92	18	10	2 488,-
		32	1460	1823	2250	2742	3297	3914							
		38	1293	1617	1999	2439	2936	3489							
		43	1149	1439	1781	2176	2624	3124							
UP-SE2008GS	K: 400V-3~50Hz V: 230V-1~50Hz	25	1634	2040	2518	3070	3693	4384	1080	488	708	92	18	10	2 488,-
		32	1462	1825	2253	2746	3302	3919							
		38	1295	1620	2002	2443	2941	3495							
		43	1151	1442	1785	2181	2630	3131							
UP-SE2010GK	K: 230V-1~50Hz V: 230V-1~50Hz	25	1892	2356	2900	3523	4220	4987	1080	488	708	92	18	10	2 769,-
		32	1685	2098	2582	3134	3754	4436							
		38	1486	1854	2284	2776	3328	3936							
		43	1318	1645	2028	2468	2962	3510							
UP-SE2010GS	K: 400V-3~50Hz V: 230V-1~50Hz	25	1894	2358	2903	3527	4226	4995	1080	488	708	92	18	10	2 769,-
		32	1687	2101	2586	3140	3761	4444							
		38	1489	1858	2289	2782	3336	3947							
		43	1321	1649	2034	2475	2971	3521							
UP-SE2012GS	K: 400V-3~50Hz V: 230V-1~50Hz	25	2529	3167	3925	4805	5808	6931	1290	540	1020	107	22	12	3 050,-
		32	2276	2851	3533	4324	5225	6236							
		38	2025	2542	3155	3867	4680	5593							
		43	1807	2272	2825	3469	4206	5036							
UP-SE2014GS	K: 400V-3~50Hz V: 230V-1~50Hz	25	2931	3663	4532	5535	6673	7941	1290	540	1020	107	22	12	3 223,-
		32	2631	3290	4069	4969	5989	7127							
		38	2338	2930	3629	4437	5355	6381							
		43	2085	2616	3246	3975	4806	5737							
UP-SE2017GS	K: 400V-3~50Hz V: 230V-1~50Hz	25	3438	4288	5290	6441	7737	9170	1290	540	1020	107	22	12	3 310,-
		32	3076	3837	4732	5760	6917	8198							
		38	2726	3407	4207	5127	6164	7315							
		43	2426	3036	3753	4581	5516	6557							
UP-SE2020GS	K: 400V-3~50Hz V: 230V-1~50Hz	25	3973	4943	6079	7375	8822	10410	1290	540	1020	107	22	12	3 418,-
		32	3540	4405	5414	6566	7852	9265							
		38	3128	3897	4796	5822	6970	8234							
		43	2777	3463	4266	5184	6216	7354							





# Refra<sup>®</sup>

Chladiace zariadenia REFRA presne podľa Vašich požiadaviek.

Agregáty, združené jednotky, chillery, zariadenia pre spätné získavanie tepla s kompresormi Bitzer, Copeland DWM, Scroll, Stream, Danfoss, Bock.

**Kontaktujte svojich predajcov pre získanie cenovej ponuky !**



# Výparníky a příslušenstvo

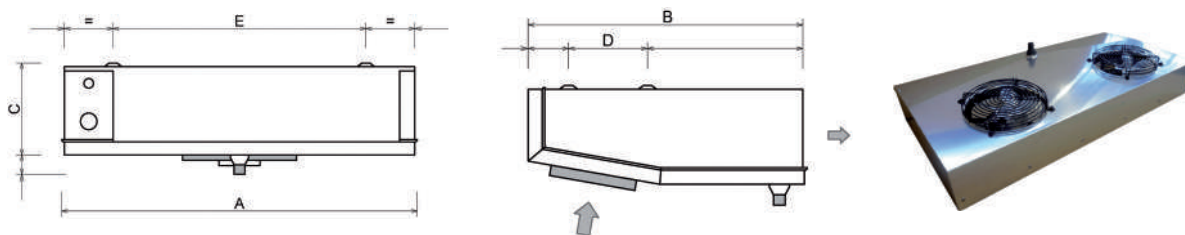

**ROEN EST podstropné výparníky SLIM (ventilátor 200 mm)**

Typ	Počet ventilátorov	Rozmery					Prípoje		Výstup kondenzu
		A [mm]	B [mm]	C [mm]	D [mm]	E [mm]	Vstup[mm]	Výstup [mm]	
SD.x.20.1.04/06	1	410	440	125	200	300	9,52	9,52	1/2"
SD.x.20.1.08/12	1	610	440	125	200	500	9,52	9,52	1/2"
SD.x.20.2.04/06	2	610	440	125	200	500	9,52	9,52	1/2"
SD.x.20.2.08/12	2	860	440	125	200	2x375	9,52	9,52	1/2"
SD.x.20.3.xx	3	1110	440	125	200	2x500	12	16	1/2"
SD.x.20.4.xx	4	1360	440	125	200	3x410	12	16	1/2"

H - 4/8 mm Rozostup lamiel	Menovitý výkon $\Delta T8$	Menovitý výkon $\Delta T10$	Prietok vzduchu	Plocha	Objem	Príkion el. odtápania	Hmotnosť	DTN obj. kód	Cena bez DPH
	kW	kW	m <sup>3</sup> /s	m <sup>2</sup>	dm <sup>3</sup>	kW	kg		
SD.H.20.1.04-4M	0,30	0,42	220	1,6	0,5	0,4	4,7	161.49.1000	168,-
SD.H.20.1.06-4M	0,41	0,58	200	2,4	0,7	0,4	5,2	161.49.1005	185,-
SD.H.20.2.04-4M	0,71	1,00	380	2,7	0,8	0,6	7,9	161.49.1020	244,-
SD.H.20.2.08-4M	0,99	1,40	490	4,0	1,1	0,9	9,3	161.49.1030	280,-
SD.H.20.2.12-4M	1,10	1,55	450	6,0	1,7	0,9	10,4	161.49.1035	310,-
SD.H.20.3.04-4M	1,29	1,82	650	5,3	1,5	1,1	12,8	161.49.1040	352,-
SD.H.20.3.06-4M	1,52	2,14	600	7,9	2,2	1,1	14,2	161.49.1045	386,-
SD.H.20.4.06-4M	1,80	2,54	720	9,9	2,8	1,3	18,0	161.49.1055	449,-

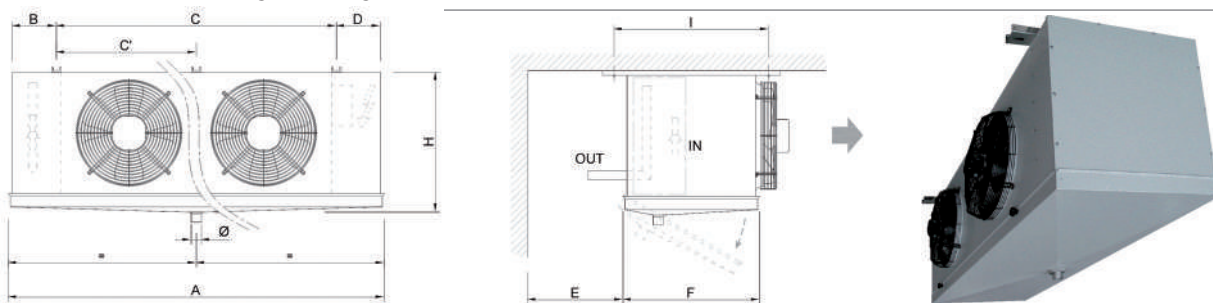
**ROEN EST podstropné výparníky CUBIC (ventilátor 300 mm)**

Typ	Počet ventilátorov	Rozmery										Prípoje		Výstup kon-denzu
		A [mm]	B [mm]	C [mm]	C' [mm]	D [mm]	E [mm]	F [mm]	H [mm]	I [mm]	Vstup [mm]	Výstup [mm]		
CC.x.30.1.xx	1	750	130	470	/	130	400	380	410	415	12	16	1"	
CC.x.30.2.xx	2	1200	130	920	/	130	400	380	410	415	12	16	1"	
CC.x.30.3.xx	3	1650	130	1370	/	130	400	380	410	415	16	22	1"	
CC.x.30.4.xx	4	2100	130	1820	/	130	400	380	410	415	16	22	1"	
CC.x.30.5.xx	5	2550	130	2270	900	130	400	380	410	415	22	28	1-1/4"	

Model M - stredné teploty	Menovitý výkon $\Delta T8$	Menovitý výkon $\Delta T10$	Prietok vzduchu	Dofuk	Plocha	Objem	Príkon el. odtápania	Hmotnosť	DTN obj. kód	Cena bez DPH
	kW	kW	m <sup>3</sup> /s	m	m <sup>2</sup>	dm <sup>3</sup>	kW	kg		
CC.M.30.1.04-4M	1,70	2,40	940	11	5,3	2,0	1,1	16	161.49.2405	578,-
CC.M.30.1.06-4M	2,10	2,96	870	10	7,9	3,0	1,5	18	161.49.2410	654,-
CC.M.30.1.08-4M	2,50	3,50	830	10	10,5	4,0	1,9	21	161.49.2415	728,-
CC.M.30.2.04-4M	3,40	4,79	1880	11	10,6	3,8	2,1	26	161.49.2425	829,-
CC.M.30.2.06-4M	4,20	5,92	1700	10	15,8	5,7	2,8	31	161.49.2430	959,-
CC.M.30.2.08-4M	5,00	7,00	1660	10	21,0	7,5	3,5	35	161.49.2435	1 093,-
CC.M.30.3.04-4M	5,10	7,19	2820	11	16,0	5,6	3,3	37	161.49.2445	1 074,-
CC.M.30.3.06-4M	6,50	9,16	2610	10	24,0	8,5	4,4	43	161.49.2450	1 264,-
CC.M.30.3.08-4M	7,50	10,50	2490	10	32,0	11,2	5,5	50	161.49.2455	1 301,-
CC.M.30.4.04-4M	6,70	9,38	3760	11	22,0	7,5	4,4	48	161.49.2465	1 214,-
CC.M.30.4.06-4M	8,70	12,27	3480	10	32,0	11,1	5,9	56	161.49.2470	1 572,-
CC.M.30.4.08-4M	10,00	14,00	3320	10	42,0	14,9	7,4	64	161.49.2475	1 823,-
CC.M.30.5.04-4M	8,50	11,90	5000	12	20,0	6,9	5,5	52	161.49.2485	1 547,-
CC.M.30.5.06-4M	10,80	15,12	4700	11	27,0	9,3	5,5	58	161.49.2490	1 849,-
CC.M.30.5.08-4M	12,50	17,62	4150	10	53,0	18,5	9,2	79	161.49.2495	2 161,-

Model L - mrazenie	Menovitý výkon $\Delta T8$	Menovitý výkon $\Delta T10$	Prietok vzduchu	Dofuk	Plocha	Objem	Príkon el. odtápania	Hmotnosť	DTN obj. kód	Cena bez DPH
	kW	kW	m <sup>3</sup> /s	m	m <sup>2</sup>	dm <sup>3</sup>	kW	kg		
CC.L.30.1.04-4M	1,48	1,90	1050	11	6,0	2,3	1,5	17	161.49.2510	669,-
CC.L.30.1.05-4M	1,65	2,31	1000	10	7,5	2,9	1,5	18	161.49.2515	628,-
CC.L.30.1.06-4M	1,84	2,50	950	10	9,0	3,5	1,9	21	161.49.2520	725,-
CC.L.30.2.04-4M	3,01	4,60	2100	11	12,0	4,4	2,8	28	161.49.2535	926,-
CC.L.30.2.05-4M	3,44	4,80	2000	10	15,0	5,5	2,8	31	161.49.2540	1 015,-
CC.L.30.2.06-4M	3,93	5,50	1900	10	18,0	6,6	3,5	35	161.49.2545	1 101,-
CC.L.30.3.04-4M	4,55	6,20	3150	11	18,0	6,4	4,4	40	161.49.2560	1 167,-
CC.L.30.3.05-4M	5,28	7,30	3000	10	22,0	8,0	4,4	43	161.49.2565	1 282,-
CC.L.30.3.06-4M	5,89	8,25	2850	10	26,0	9,6	5,5	50	161.49.2570	1 397,-
CC.L.30.4.04-4M	6,08	8,51	4200	11	24,0	8,5	5,9	52	161.49.2585	1 403,-
CC.L.30.4.05-4M	7,09	10,00	4000	10	29,0	10,7	5,9	56	161.49.2590	1 546,-
CC.L.30.4.06-4M	7,92	11,09	3800	10	35,0	13,0	7,4	64	161.49.2595	1 685,-
CC.L.30.5.04-4M	7,62	10,67	5250	11	29,0	10,6	7,4	63	161.49.2610	1 641,-
CC.L.30.5.05-4M	8,87	12,42	5000	10	36,0	13,2	7,4	69	161.49.2615	1 808,-
CC.L.30.5.06-4M	9,91	14,00	4750	10	44,0	15,8	9,2	79	161.49.2620	1 973,-

## ROEN EST podstropné výparníky CUBIC (ventilátor 350 mm)

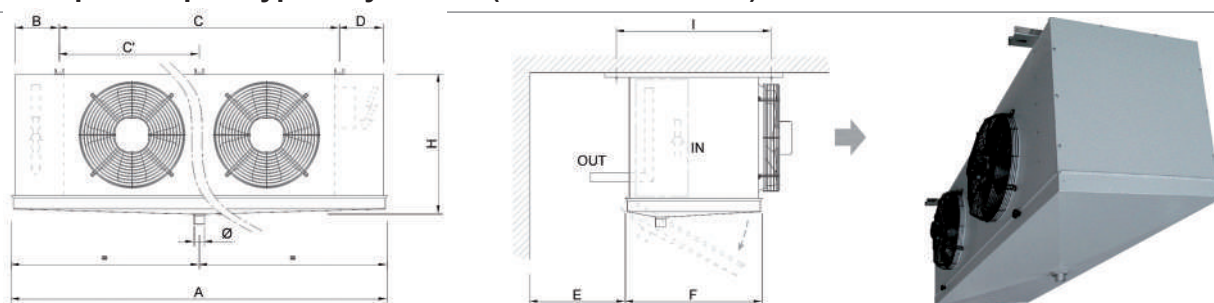

Typ	Počet ventilátorov	Rozmery									Prípoje		Výstup kondenzu
		A [mm]	B [mm]	C [mm]	C' [mm]	D [mm]	E [mm]	F [mm]	H [mm]	I [mm]	vstup [in.]	Výstup [mm]	
CC.x.35.1.xx	1	800	520	/	130	450	500	540	570	570	1/2"	22	1"
CC.x.35.2.xx	2	1300	1020	/	130	450	500	540	570	570	1/2"	22	1"
CC.x.35.3.xx	3	1800	1520	/	130	450	500	540	570	570	5/8"	28	1"
CC.x.35.4.xx	4	2300	2020	1000	130	450	500	540	570	570	5/8"	28	1-1/4"
CC.x.35.5.xx	5	2800	2520	1000	130	450	500	540	570	570	5/8"	28	1-1/4"

Model M - stredné teploty	Menovitý výkon $\Delta T8$	Menovitý výkon $\Delta T10$	Prietok vzduchu	Dofuk	Plocha	Objem	Príkon el. odtápania	Hmotnosť	DTN obj. kód	Cena bez DPH
	kW	kW	m <sup>3</sup> /s	m	m <sup>2</sup>	dm <sup>3</sup>	kW	kg		
CC.M.35.1.04-4M	2,8	3,92	2580	18	11,2	2,9	1,2	25	161.49.2200	1 010,-
CC.M.35.1.06-4M	3,8	5,32	2320	16	16,8	4,3	2,0	29	161.49.2205	1 169,-
CC.M.35.1.08-4M	4,4	6,16	2170	15	22,0	5,8	2,4	32	161.49.2210	1 323,-
CC.M.35.2.04-4M	5,7	7,98	5160	18	22,0	5,8	2,2	41	161.49.2215	1 432,-
CC.M.35.2.06-4M	7,5	10,5	4640	16	33,0	8,7	3,8	48	161.49.2220	1 657,-
CC.M.35.2.08-4M	8,8	12,41	4340	15	45,0	11,6	4,5	55	161.49.2225	1 881,-
CC.M.35.3.06-4M	11,3	15,82	6960	16	50,0	13,0	5,6	69	161.49.2230	2 163,-
CC.M.35.3.08-4M	13,2	18,61	6510	15	67,0	17,4	6,7	79	161.49.2235	2 455,-
CC.M.35.4.06-4M	15,0	21,00	9280	16	67,0	17,4	7,5	89	161.49.2240	2 743,-
CC.M.35.4.08-4M	17,6	24,82	8680	15	89,0	23,2	9,0	104	161.49.2245	2 971,-
CC.M.35.5.06-4M	18,8	26,32	11600	16	84,0	22,0	9,5	110	161.49.2250	3 235,-
CC.M.35.5.08-4M	22,0	31,02	10850	15	112,0	29,0	11,4	127	161.49.2255	3 671,-

Model L - mrazenie	Menovitý výkon $\Delta T8$	Menovitý výkon $\Delta T10$	Prietok vzduchu	Dofuk	Plocha	Objem	Príkon el. odtápania	Hmotnosť	DTN obj. kód	Cena bez DPH
	kW	kW	m <sup>3</sup> /s	m	m <sup>2</sup>	dm <sup>3</sup>	kW	kg		
CC.L.35.1.04-4M	2,5	3,5	2630	18	8,8	2,9	1,2	24	161.49.2300	1 000,-
CC.L.35.1.06-4M	3,4	4,76	2430	17	13,2	4,3	2,0	27	161.49.2305	1 155,-
CC.L.35.1.08-4M	4,0	5,64	2220	15	17,8	5,8	2,4	30	161.49.2310	1 301,-
CC.L.35.2.04-4M	4,9	6,86	5260	18	17,5	5,8	2,2	39	161.49.2315	1 412,-
CC.L.35.2.06-4M	6,7	9,38	4860	17	26,0	8,7	3,8	45	161.49.2320	1 627,-
CC.L.35.2.08-4M	8,0	11,28	4440	15	35,0	11,6	4,5	51	161.49.2325	1 840,-
CC.L.35.3.06-4M	10,1	14,14	7290	17	39,0	13,0	5,6	64	161.49.2330	2 116,-
CC.L.35.3.08-4M	12,0	16,92	6660	15	53,0	17,4	6,7	73	161.49.2335	2 390,-
CC.L.35.4.06-4M	13,4	18,76	9720	17	53,0	17,4	7,5	83	161.49.2340	2 677,-
CC.L.35.4.08-4M	16,0	22,56	8880	15	70,0	23,2	9,0	95	161.49.2345	2 881,-
CC.L.35.5.06-4M	16,8	23,52	121,5	17	66,0	22,0	9,5	101	161.49.2350	3 150,-
CC.L.35.5.08-4M	20,0	28,20	11100	15	88,0	29,0	11,4	116	161.49.2355	3 561,-

Výparníky sú vykáblované do inštaláčnej krabice (ventilátory aj odtápanie, ak je inštalované).



# WIND

## WIND axiálne ventilátory

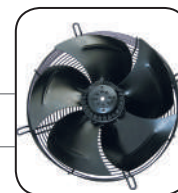

Priemer [mm]	Typ	Prevedenie	Menovité napätie [V/Hz]	Vzdialenosť úchytovej [mm]	Prúd [A]	Príkon [W]	Otáčky [r/min]	Prietok vzduchu [m³/h]	Hmotnosť [kg]	Hlučnosť [dBA]	Kondenz. [µF]	DTN obj. kód	Cena bez DPH
200	YWF2E-200S	sací	230/50	260	0,26	55	2 500	1 800	3	60	3	521.57.1000	52,-
	YWF2E-200B	tlačný	230/50		0,26	55	2 500	1 800	3	60	3	521.57.1001	52,-
	YWF4E-200S	sací	230/50		0,21	40	1 400	1 460	3	55	3	521.57.1005	52,-
	YWF4E-200B	tlačný	230/50		0,21	40	1 400	1 460	3	55	3	521.57.1205	52,-
250	YWF2E-250S	sací	230/50	320	0,45	90	2 200	1 358	3	60	3	521.57.1015	53,-
	YWF4E-250S	sací	230/50		0,21	50	1 380	1 108	3	55	3	521.57.1025	53,-
	YWF4E-250B	tlačný	230/50		0,21	50	1 380	1 108	3	55	3	521.57.1210	53,-
300	YWF4E-300S	sací	230/50	360	0,35	75	1 380	1 716	3,3	58	3	521.57.1045	70,-
	YWF4E-300B	tlačný	230/50		0,35	75	1 380	1 716	3,3	58	3	521.57.1230	70,-
315	YWF4E-315S	sací	230/50	390	0,45	95	1 380	1 780	3,5	58	4	521.57.1055	75,-
330	YWF4E-330S	sací	230/50	402	0,50	95	1 300	1 635	4	62	4	521.57.1060	80,-
350	YWF4D-350S	sací	380/50	422	0,38	140	1 380	2 688	4,9	62	-	521.57.1065	83,-
	YWF4E-350S	sací	230/50		0,65	140	1 380	2 666	4,9	62	4	521.57.1070	83,-
	YWF4D-350B	tlačný	380/50		0,38	140	1 380	2 688	4,9	62	-	521.57.1235	83,-
	YWF4E-350B	tlačný	230/50		0,65	140	1 380	2 666	4,9	62	4	521.57.1240	83,-
400	YWF4D-400S	sací	380/50	470	0,47	180	1 380	4 008	5,6	68	-	521.57.1085	92,-
	YWF4E-400S	sací	230/50		0,80	180	1 380	3 861	5,6	68	6	521.57.1090	92,-
	YWF4D-400B	tlačný	380/50		0,47	180	1 380	4 008	5,6	68	-	521.57.1255	92,-
	YWF4E-400B	tlačný	230/50		0,80	180	1 380	3 861	5,6	68	6	521.57.1260	92,-
450	YWF4D-450S	sací	380/50	522	0,60	250	1 350	5 180	7,2	68	-	521.57.1105	102,-
	YWF4E-450S	sací	230/50		1,20	250	1 350	5 000	7,2	68	8	521.57.1110	102,-
	YWF4D-450B	tlačný	380/50		0,60	250	1 350	5 180	7,2	68	-	521.57.1275	102,-
	YWF4E-450B	tlačný	230/50		1,20	250	1 350	5 000	7,2	68	8	521.57.1280	102,-
500	YWF4D-500S	sací	380/50	570	0,90	450	1 300	6 568	9,5	72	-	521.57.1125	140,-
	YWF4E-500S	sací	230/50		1,85	420	1 300	6 420	9,5	72	10	521.57.1130	140,-
	YWF4E-500B	tlačný	230/50		1,85	420	1 300	6 420	9,5	72	10	521.57.1295	140,-
550	YWF4D-550S	sací	380/50	622	1,20	600	1 300	8 716	10,5	75	-	521.57.1145	183,-
	YWF4D-550B	tlačný	230/50		1,20	600	1 300	8 716	10,5	75	12	521.57.1150	183,-
630	YWF4D-630S	sací	380/50	750	1,60	800	1 320	13 040	15	78	-	521.57.1165	216,-
	YWF4E-630S	sací	230/50		3,50	750	1 360	11 648	15	78	16	521.57.1170	216,-
	YWF6D-630S	sací	380/50		1,60	550	900	9 640	15	75	-	521.57.1175	216,-
	YWF6D-630B	tlačný	380/50		1,60	550	900	9 640	15	75	-	521.57.1300	216,-
710	YWF6D-710S	sací	380/50	840	3,50	1 200	900	14 800	28	80	-	521.57.1185	415,-

## WIND tangenciálne ventilátory

Typ	Prúd [A]	Príkon [W]	Prietok vzduchu [m³/h]	Otáčky [r/min]	A	B	C	DTN obj. kód	Cena bez DPH
					mm	mm	mm		
YGF60.120	0,20	19	92	2 500	146	136	120	524.57.1010	21,50
YGF60.183	0,30	28	140	2 500	206	196	183	524.57.1015	25,-
YGF60.240	0,38	35	175	2 500	266	256	240	524.57.1020	26,50
YGF60.300	0,48	46	230	2 500	326	316	300	524.57.1025	30,-
YGF60.360	0,58	55	270	2 500	386	376	360	524.57.1030	33,50
YGF60.420	0,68	64	310	2 500	446	436	420	524.57.1035	33,50
YGF60.480	0,78	73	354	2 500	506	496	480	524.57.1040	36,50

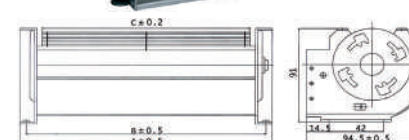

WIND AXIÁLNE VENTILÁTORY

# WIND

## WIND univerzálne motory ventilátorov

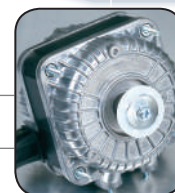

Typ	Výkon [W]	Max. lopatka [mm]	Max. podstava [mm]	A	B	C	D	E	Hmotnosť [kg]	DTN obj. kód	Cena bez DPH
				mm	mm	mm	mm	mm			
YZF5-13-18/26	5,0	200	H72	13	13	44	79	48	0,8	529.57.1000	10,-
YZF10-20-18/26	10,0	230	H84	19	13	44	85	54	1,1	529.57.1005	12,50
YZF16-25-18/26	16,0	250	H84	25	14	45	92	61	1,4	529.57.1010	14,50
YZF25-40-18/26	25,0	300	H109	40	18	49	112	80	1,8	529.57.1015	19,50
YZF34-45-18/26	34,0	300	H109	45	22	53	121	90	2,0	529.57.1020	21,-

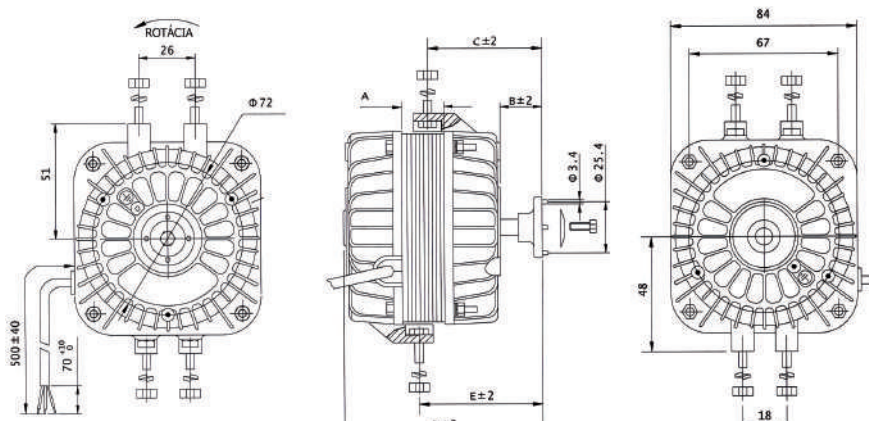

### C ventilátor

Typ	Prúd [A]	Príkon [W]	Otáčky [rpm]	Smer otáčok	Os		A	DTN obj. kód	Cena bez DPH
					Dĺžka [mm]	Priemer [mm]	mm		
YZF672	0,30	18	2400	proti smeru hodin	13	44	16	529.57.1100	8,-

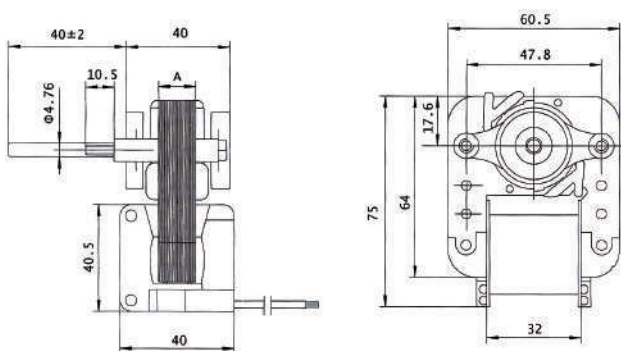

### Lopatky Sacie / Tlačné

Typ	A	19°	22°	25°	28°	31°	Prevedenie	DTN obj. kód	Cena bez DPH
	mm	B/C	B/C	B/C	B/C	B/C			
Ø154	152	23/12	26/13	29/15	32/16	36/19	sacia	529.57.2005	0,60
							tlačná	529.57.2000	0,60
Ø172	170	25/13	28/14	31/16	34/17	38/19	sacia	529.57.2015	0,70
							tlačná	529.57.2010	0,70
Ø200	196	27/14	30/15	33/17	36/18	40/20	sacia	529.57.2025	0,80
							tlačná	529.57.2020	0,80
Ø230	228	30/16	33/17	36/18	39/20	42/21	sacia	529.57.2035	0,80
							tlačná	529.57.2030	0,80
Ø250	244	31/16	34/17	37/19	40/20	43/22	sacia	529.57.2045	1,30
							tlačná	529.57.2040	1,30
Ø254	252	32/18	35/21	38/23	41/24	44/29	sacia	529.57.2055	1,40
							tlačná	529.57.2050	1,40
Ø300	298	37/18	41/22	44/22	48/24	52/26	sacia	529.57.2070	2,70
							tlačná	529.57.2060	2,70

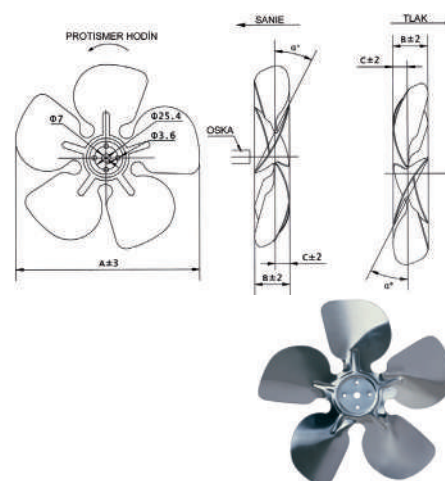

## WIND podstavy motorčekov

H	A	B	L1	L2	DTN obj. kód	Cena bez DPH
mm	mm	mm	mm	mm		
55	81	106	13	-	529.57.3000	0,30
72	81	106	13	-	529.57.3005	0,40
84	81	106	20	-	529.57.3010	0,40
109-1	81	106	14	-	529.57.3015	0,70
109-2	78	100	14	39	529.57.3020	0,70
109-3	78	100	14	49	529.57.3025	0,70

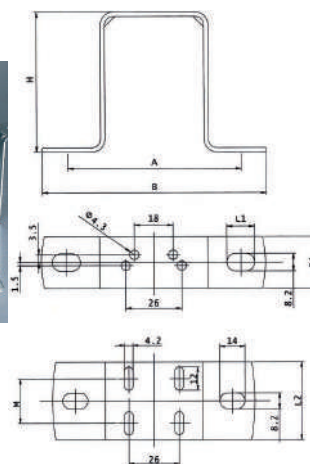

## WIND prístrojové ventilátory

Typ	Rozmer [mm]	Prúd [A]	Príkon [W]	Prietok vzduchu [m³/h]	Otáčky [r/min]	Hlučnosť [dB]	Hmotnosť [kg]	DTN obj. kód	Cena bez DPH
YJF-8038MB	80*80*38	0,15	14,0	40	2 200	23,4	0,27	522.57.1000	10,-
YJF-9238HB	92*92*38	0,07	13,0	66	2 700	28,2	0,39	522.57.1005	10,-
YJF-12025LB	120*120*26	0,09	17,4	83	1 900	35,6	0,32	522.57.1010	10,50
YJF-12038HS	120*120*38	0,11	17,1	150	2 500	36,1	0,50	522.57.1015	11,-
YJF-12038HB	120*120*38	0,12	18,0	115	2 500	37,3	0,50	522.57.1020	11,-



## Mriežky ventilátorov

Typ	A	B	C	H	DTN obj. kód	Cena bez DPH
	mm	mm	mm	mm		
Ø154	164	202	190	11	529.57.4000	1,50
Ø172	188	220	208	11	529.57.4005	2,-
Ø200	210	248	236	25	529.57.4010	2,50
Ø230	238	278	268	25	529.57.4015	3,-
Ø254	265	300	290	27	529.57.4020	3,50
Ø300	322	354	344	27	529.57.4025	4,-

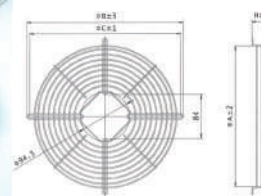

## Podporné kruhy

Typ	Ø A	Ø B	C	D	Ø E	DTN obj. kód	Cena bez DPH
	mm	mm	mm	mm	mm		
Ø172	223	180	49	25	208	529.57.5000	2,-
Ø200	246	208	49	25	236	529.57.5005	2,50
Ø230	278	238	49	25	266	529.57.5010	3,-
Ø254	300	262	49	25	290	529.57.5015	3,50
Ø300	378	308	49	30	365	529.57.5020	4,50

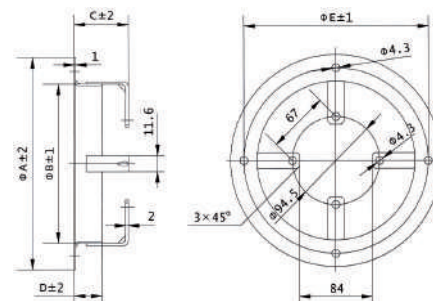



# Príslušenstvo chladiacich okruhov

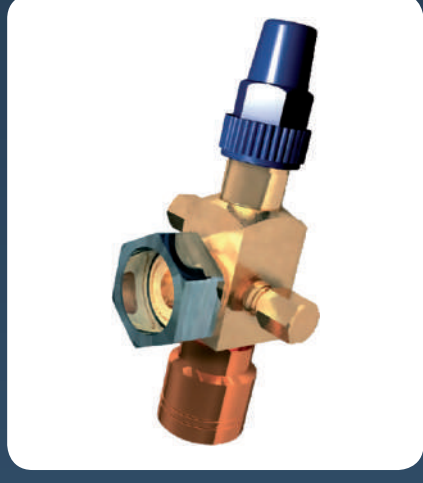



### Odlučovače chladiwa

Typ	Objem	Prípoje	DTN obj. kód	Cena bez DPH
	[L]	[mm]		
06/S-S	4,6	12/22	193.31.1000	123,-
07/S-S	5,6	16/28	193.31.1005	127,-
08/S-S	7,8	16/35	193.31.1010	178,-
09/S-S	11,0	18/42	193.31.1015	199,-
10/S-S	19,0	22/54	193.31.1020	286,-

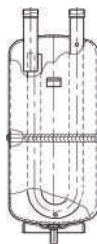

### Odlučovače chladiwa

Typ		Prípoje	DTN obj. kód	Cena bez DPH
		[mm]		
LTR-2407	-	22/12	193.40.1000	86,-
LTR-2411	-	28/16	193.40.1005	92,-
LTR-2413	-	35/18	193.40.1010	106,-
LTR-2415	-	42/22	193.40.1015	118,-

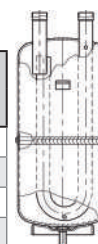

### Tlmiče hluku

Typ	Objem	Prípoje	DTN obj. kód	Cena bez DPH
	[L]	[mm]		
SLT-76/22	0,65	22	194.31.1000	57,-
SLT-76/28	0,65	28	194.31.1005	58,-
SLT-100/35	1,60	35	194.31.1010	93,-
SLT-76/18	0,53	18	194.31.1015	52,-



### Zásobníky chladiwa

Typ	Objem	Prípoje	DTN obj. kód	Cena bez DPH
	[L]			
RV-100x224	1,5	10 mm / 1"	191.31.1000	21,-
RV-120x250	2,3	10 mm / 1"	191.31.1005	23,-
RV-140x337	4,6	12 mm / 1"	191.31.1010	35,-
RV-160x344	5,6	12 mm / 1"	191.31.9000	42,-
RV-200x317	7,6	16 mm / 1"	191.31.1015	52,-
RV-220x367	11,0	16 mm / 1"	191.31.1025	73,-
RV-220x427	13,0	22 mm / 1-1/4"	191.31.1030	94,-
RV-260x388	16,0	22 mm / 1-1/4"	191.31.1035	98,-
RV-260x488	19,0	22 mm / 1-1/4"	191.31.1040	100,-
RV-300x536	30,0	35 mm / 1-1/3"	191.31.1050	217,-

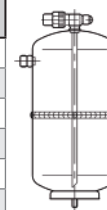

### Ventily Rotalock

Typ	Závit	Potrubie	DTN obj. kód	Cena bez DPH
	["]	[mm]		
10 mm / 3/4"	3/4"	10	206.31.1000	14,-
10 mm / 1"	1"	10	206.31.1005	15,-
12 mm / 1"	1"	12	206.31.1010	15,-
16 mm / 1"	1"	16	206.31.1015	16,-
18 mm / 1"	1"	18	206.31.1020	
12 mm / 1-1/4"	1-1/4"	12	206.31.1025	18,-
16 mm / 1-1/4"	1-1/4"	16	206.31.1030	17,-
18 mm / 1-1/4"	1-1/4"	18	206.31.1035	19,-
22 mm / 1-1/4"	1-1/4"	22	206.31.1040	22,-
28 mm / 1-1/4"	1-1/4"	28	206.31.1045	22,-
22 mm / 1-3/4"	1-3/4"	22	206.31.1050	25,-
28 mm / 1-3/4"	1-3/4"	28	206.31.1055	31,-
35 mm / 1-3/4"	1-3/4"	35	206.31.1060	31,-
42 mm / 1-3/4"	1-3/4"	42	206.31.1065	32,-
42 mm / 2-1/4"	2-1/4"	42	206.31.1070	53,-



### Tlmiče chvenia

Typ	Kód Castel	Dĺžka	Prípoje	DTN obj. kód	Cena bez DPH
		[mm]			
VTG010	7690/M10	230	10	335.86.1000	14,-
VTG012	7690/M12	230	12	335.86.1005	14,-
VTG016	7690/5	255	16	335.86.1010	17,-
VTG018	7690/M18	255	18	335.86.1015	19,-
VTG022	7690/7	290	22	335.86.1020	24,-
VTG028	7690/M28	330	28	335.86.1025	32,-
VTG035	7690/11	375	35	335.86.1030	43,-
VTG042	7690/M42	430	42	335.86.1035	69,-
VTG054	7690/17	510	54	335.86.1040	101,-
VTG064	7690/M64	690	64	335.86.1045	230,-
VTG076	7690/24	690	76	335.86.1050	266,-



### Prevlečné matice

Typ	Závit	Potrubie	DTN obj. kód	Cena bez DPH
	["]	[mm]		
7010/22	1/4"	6	332.14.1000	0,80
7020/32	3/8"	6	332.14.1005	1,40
7030/3M8	3/8"	8	332.14.1010	1,40
7010/33	3/8"	3/8"	332.14.1013	1,40
7030/3M10	3/8"	10	332.14.1015	1,40
7030/4M10	1/2"	10	332.14.1020	2,-
7030/4M12	1/2"	12	332.14.1025	2,-
7010/55	5/8"	16	332.14.1030	2,40
7030/6M18	3/4"	18	332.14.1035	4,-
SN-4	1/4"	6	332.40.2000	0,55
SN-6	3/8"	10	332.40.2005	1,-
SN-8	1/2"	12	332.40.2010	1,50
SN-10	5/8"	16	332.40.2015	1,50
SN-12	3/4"	18	332.40.2020	3,-

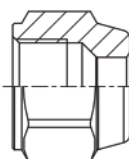

### Spojky

Typ	Závit	DTN obj. kód	Cena bez DPH
	["]		
UN-4	1/4"	332.40.1000	1,10
UN-6	3/8"	332.40.1005	1,80
UN-8	1/2"	332.40.1010	2,70
UN-10	5/8"	332.40.1015	4,-
UN-12	3/4"	332.40.1020	6,50



### T spojky so závitom

Typ	Závit	DTN obj. kód	Cena bez DPH
	["]		
UT-4	1/4"	332.40.1100	3,60
UT-6	3/8"	332.40.1105	6,50
UT-8	1/2"	332.40.1110	10,-
UT-10	5/8"	332.40.1115	14,-

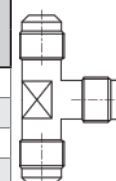

## 90° spojky so závitom

Typ	Závit	DTN obj. kód	Cena bez DPH
	["]		
UE-4 - 7210/2	1/4"	332.40.1200	3,80
UE-8 - 7210/3	3/8"	332.40.1205	5,90
UE-6 - 7210/4	1/2"	332.40.1210	10,90
UE-10 - 7210/5	5/8"	332.40.1215	13,20

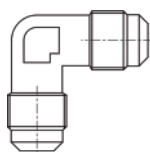

## Teflónové tesnenia rotalock ventilov

Typ	Rozmer	DTN obj. kód	Cena bez DPH
	["]		
3/4"	3/4"	206.31.1500	0,50
1"	1"	206.31.1505	0,55
1-1/4"	1-1/4"	206.31.1510	0,65
1-3/4"	1-3/4"	206.31.1515	0,75
2-1/4"	2-1/4"	206.31.1520	1,40

## Plniace ventily

Typ	Prípoje	DTN obj. kód	Cena bez DPH
Plniaci ventil s trúbkou (7 cm)	1/4"SAE - 6 mm	332.40.3000	1,35
Plniaci ventil bez trúbky	1/4"SAE - 6 mm	332.53.1005	0,75
Plniaci ventil s trúbkou (10 cm)	1/4"SAE - 1/4"ODS	332.53.1015	1,35
Redukcia Castel 7140/21	1/4"SAE - 1/8"NPT	332.14.2300	1,60
Plniaci ventil Castel 8354/22	1/4"SAE - 1/4"NPT	332.14.4020	1,80
Čiapočka Castel 8392/A	1/4"SAE	332.14.4095	0,50
Ihla Castel 8394/B	-	332.14.4105	0,50



## Medené tesnenia

Typ	Rozmer	DTN obj. kód	Cena bez DPH
7580/2	1/4"	332.14.8000	0,18
7580/3	3/8"	332.14.8005	0,25
7580/4	1/2"	332.14.8010	0,30
7580/5	5/8"	332.14.8015	0,32

## Kapiláry s maticami

Typ	Dĺžka	Ihla	DTN obj. kód	Cena bez DPH
	[m]			
MG-10	1,0	Nie	323.40.1000	2,40
MG-15	1,5	Nie	323.40.1005	3,20
K-06	0,6	Áno	323.14.1004	3,40
K-10	1,0	Áno	323.14.1005	3,80
K-15	1,5	Áno	323.14.1010	4,20



## Kapilárne potrubie

Typ	Dĺžka	Vnút./ Vonk.	DTN obj. kód	Cena bez DPH
	[m]	[mm]		
TC-26	30	0,7/1,9	323.46.1000	38,-
TC-31	30	0,8/2,0	323.46.1005	42,-
TC-36	30	0,9/2,1	323.46.1010	45,-
TC-42	30	1,0/2,2	323.46.1015	48,-
TC-44	30	1,1/2,3	323.46.1055	50,-
TC-49	30	1,25/2,45	323.46.1020	56,-
TC-50	30	1,3/2,5	323.46.1060	60,-
TC-55	30	1,4/2,6	323.46.1025	65,-
TC-59	30	1,5/2,7	323.46.1030	68,-
TC-64	30	1,6/2,8	323.46.1035	70,-
TC-70	30	1,8/3,0	323.46.1040	74,-
TC-75	30	1,9/3,1	323.46.1065	78,-
TC-80	30	2,0/3,2	323.46.1045	80,-
TC-90	30	2,3/3,5	323.46.1050	84,-



## Tesniaca pasta

Typ	DTN obj. kód	Cena bez DPH
TRU-BLU	477.99.1285	5,60







# Prvky chladiarenskej automatizácie



PRVKY CHLADIARENskej AUTOMATIZÁCIE



## Termostatické expanzné ventily SANHUA RFKH

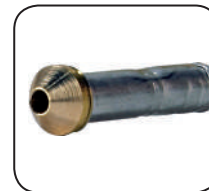

Chladivo	Typ	Obj. číslo	Vstup ĽA		Výstup ĽB		Vyrovnávanie ĽC			Cena bez DPH Eur
			Skrutkovací [„]	Skrutkovací [„]	Pájkovací [mm]	[„]	Skrutkovací [„]	Pájkovací [mm]	Pájkovací [mm]	
R22	RFKH01-6.0-22	10201002502	3/8	1/2						28,70
	RFKH01E-6.0-13	10201002402		1/2			1/4			34,52
	RFKH01-6.0-26	10201002602			12					28,70
	RFKH01E-6.0-06	10201002102			12				6	34,52
	RFKH01-6.0-07	10201002202					1/2			28,70
	RFKH01E-6.0-08	10201002302					1/2		1/4	34,52
R407C	RFKH02-6.3-24	10201002902	3/8	1/2						28,70
	RFKH02E-6.3-20	10201002802		1/2			1/4			34,52
	RFKH02-6.3-27	10201003002			12					28,70
	RFKH02E-6.3-28	10201003102			12				6	34,52
	RFKH02-6.3-32	10201003202					1/2			28,70
	RFKH02E-6.3-18	10201002702					1/2		1/4	34,52
R404A / R507A	RFKH03-4.8-21	10201003702	3/8	1/2						28,70
	RFKH03E-4.8-15	10201003802		1/2			1/4			34,52
	RFKH03-4.8-03	10201003402			12					28,70
	RFKH03E-4.8-02	10201003302			12				6	34,52
	RFKH03-4.8-09	10201003502					1/2			28,70
	RFKH03E-4.8-10	10201003602					1/2		1/4	34,52
R134a	RFKH04-2.9-23	10201004102	3/8	1/2						28,70
	RFKH04E-2.9-19	10201004002		1/2			1/4			34,52
	RFKH04-2.9-29	10201004202			12					28,70
	RFKH04E-2.9-17	10201003902			12				6	34,52
	RFKH04-2.9-30	10201004302					1/2			28,70
	RFKH04E-2.9-31	10201004402					1/2		1/4	34,52
R410A	RFKH05-7.6-66	10201005702	3/8	1/2						28,70
	RFKH05E-7.6-33	10201005202		1/2			1/4			34,52
	RFKH05-7.6-37	10201005602			12					28,70
	RFKH05E-7.6-36	10201005502			12				6	34,52
	RFKH05-7.6-35	10201005402					1/2			28,70
	RFKH05E-7.6-34	10201005302					1/2		1/4	34,52
R407A / R407F	RFKH07-6.0-43	10201004802	3/8	1/2						28,70
	RFKH07E-6.0-42	10201004702		1/2			1/4			34,52
	RFKH07-6.0-44	10201004902			12					28,70
	RFKH07E-6.0-41	10201004602			12				6	34,52
	RFKH07-6.0-45	10201005002					1/2			28,70
	RFKH07E-6.0-46	10201005102					1/2		1/4	34,52
R448A / R449A	RFKH08-6.1-49	10201012802	3/8	1/2						28,70
	RFKH08E-6.1-48	10201012402		1/2			1/4			34,52
	RFKH08-6.1-50	10201013302			12					28,70
	RFKH08E-6.1-47	10201012302			12				6	34,52
	RFKH08-6.1-51	10201012502					1/2			28,70
	RFKH08E-6.1-52	10201012602					1/2		1/4	34,52
R452A	RFKH11-4.5-55	10201013602	3/8	1/2						28,70
	RFKH11E-4.5-54	10201013502		1/2			1/4			34,52
	RFKH11-4.5-56	10201013702			12					28,70
	RFKH11E-4.5-53	10201013402			12				6	34,52
	RFKH11-4.5-57	10201013802					1/2			28,70
	RFKH11E-4.5-58	10201013902					1/2		1/4	34,52





### Expanzné ventily Sanhua Dýzy Sanhua

Model	Obj. názov	Obj. číslo	Číslo dýzy	Nominálny výkon [kW]						Cena bez DPH Eur
				R22	R407C	R404A	R134a	R410A	R407A R407F	
RFKH-023-0X	RFK-24097	10202001702	0X	1.0	1.0	0.7	0.69	1.3	1.0	7,06
RFKH-023-00	RFK-24098	10202001002	0	1.9	2.1	1.4	1.2	2.5	1,8	7,06
RFKH-023-01	RFK-24099	10202001102	1	3.8	4.0	2.8	2.1	5.0	3,7	7,06
RFKH-023-02	RFK-24100	10202001202	2	5.1	5.4	4.0	2.7	6.2	5,1	7,06
RFKH-023-03	RFK-24101	10202001302	3	8.6	9.2	6.8	4.4	11.2	8,6	7,06
RFKH-023-04	RFK-24102	10202001402	4	13.2	13.9	10.8	6.5	17.0	13,4	7,06
RFKH-023-05	RFK-24103	10202001502	5	18.1	18.5	14.1	8.6	21.3	17,6	7,06
RFKH-023-06	RFK-24104	10202001602	6	21.3	22.1	16.8	10.3	26.8	21,2	7,06

### Porovnanie veľkosti dýz pre chladivo R404A a výkonové tabuľky

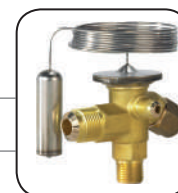
Výkon počítaný pre $T_e=+5^{\circ}\text{C}$ , $T_k=32^{\circ}\text{C}$ , podchladenie 4K				Výkon počítaný pre $T_e=+4^{\circ}\text{C}$ , $T_k=38^{\circ}\text{C}$ , podchladenie 1K			
		<b>Honeywell</b>				<b>Honeywell</b>	
Séria: TS2, TES2		Séria: TMV(X), TMV(X)BL, TMVL(X)		Séria: TI-SW, TIE-SW, TIS-SW, TISE-SW		Séria: TMV(X), TMV(X)BL, TMVL(X)	
Veľkosť dýzy	Výkon [kW]	Veľkosť dýzy	Výkon [kW]	Veľkosť dýzy	Výkon [kW]	Veľkosť dýzy	Výkon [kW]
0X	0.38	0.3	0.37	00	0.4	0.3	0.36
00	0.7	0.5	0.69	0	1.0	0.5	0.68
		0.7	0.99			0.7	0.97
01	1.6	1.0	1.4	1	2.3	1.0	1.4
02	2.1	1.5	2.3			1.5	2.2
		2.0	2.9	2.0	2.8		
03	4.2	2.5	4.2	2	3.9	2.5	4.1
04	6.0	3.0	6.6			3.0	6.5
05	7.7	3.5	8.7	4	10.1	3.5	8.6
06	9.1	4.5	12.2			4.5	12.0
		4.75	16.1	5	12.3		
				6	14.2	4.75	15.8



## Termostatické expanzné ventily T2 / TE2

Skrutkovací x skrutkovací prípoj

Chladivo	Typ	Vyrovnávanie (skrutkovacie)	Kapilára m	Prípoj		Kód Danfoss / DTN obj. číslo / Cena bez DPH					
				Vstup / Výstup		N rozsah: -40°C - +10°C		NM rozsah: -40°C - -5°C	NL rozsah: -40°C - -15°C	B rozsah: -60°C - -25°C	
				in. x in.	mm x mm	Bez MOP	MOP +15°C	MOP 0°C	MOP -10°C	Bez MOP	MOP -20°C
R22	TX 2	-	1,50	3/8" x 1/2"	10 x 12	<b>068Z3206</b>	<b>068Z3208</b>	<b>068Z3224</b>	<b>068Z3226</b>	<b>068Z3207</b>	<b>068Z3228</b>
						201.18.1000	201.18.1005	201.18.1006	201.18.1007	201.18.1008	201.18.1010
			64,10	64,10	64,10	64,10	64,10	64,10			
	TEX 2	1/4"	1,50	3/8" x 1/2"	10 x 12	<b>068Z3209</b>	<b>068Z3211</b>	<b>068Z3225</b>	<b>068Z3227</b>	<b>068Z3210</b>	<b>068Z3229</b>
201.18.1050						201.18.1055	201.18.1056	201.18.1057	201.18.1058	201.18.1060	
				102,-	102,-	102,-	102,-	102,-	102,-	102,-	
R407C	TZ2	-	1,50	3/8" x 1/2"	10 x 12	<b>068Z3496</b>	<b>068Z3514</b>				
						201.18.1015	201.18.1130				
					50,60	50,60					
	TEZ2	1/4"	1,50	3/8" x 1/2"	10 x 12	<b>068Z3501</b>	<b>068Z3517</b>				
201.18.1065						201.18.1070					
				80,60	80,60						
R134a	TN2	-	1,50	3/8" x 1/2"	10 x 12	<b>068Z3346</b>	<b>068Z3347</b>	<b>068Z3393</b>	<b>068Z3369</b>		
						201.18.1020	201.18.1021	201.18.1022	201.18.1023		
					50,60	50,60	50,60	50,60			
	TEN 2	1/4"	1,50	3/8" x 1/2"	10 x 12	<b>068Z3348</b>	<b>068Z3349</b>	<b>068Z3392</b>	<b>068Z3370</b>		
201.18.1075						201.18.1080	201.18.1081	201.18.1082			
				80,60	80,60	80,60	80,60				
R404A R507	TS2	-	1,50	3/8" x 1/2"	10 x 12	<b>068Z3400</b>	<b>068Z3402</b>	<b>068Z3406</b>	<b>068Z3408</b>	<b>068Z3401</b>	<b>068Z3410</b>
						201.18.1025	201.18.1030	201.18.1035	201.18.1040	201.18.1041	201.18.1045
					50,60	50,60	50,60	50,60	50,60	50,60	
	TES2	1/4"	1,50	3/8" x 1/2"	10 x 12	<b>068Z3403</b>	<b>068Z3405</b>	<b>068Z3407</b>	<b>068Z3409</b>	<b>068Z3404</b>	<b>068Z3411</b>
201.18.1085						201.18.1090	201.18.1095	201.18.1100	201.18.1101	201.18.1105	
				80,60	80,60	80,60	80,60	80,60	80,60	80,60	

EXPANZNÉ VENTILY T2



## Dýzy T2 / TE2

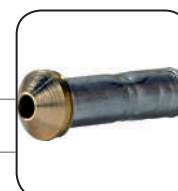

Číslo dýzy	N rozsah: -40 - +10°C				Kód Danfoss	DTN obj. číslo	Cena bez DPH
	Menovitý výkon (kW)						
	R22	R407C	R134a	R404A R507			
<b>0X</b>	0,5	0,5	0,4	0,38	068-2002	<b>201.18.1500</b>	<b>18,80</b>
<b>00</b>	1,0	1,1	0,9	0,7	068-2003	<b>201.18.1501</b>	<b>18,80</b>
<b>01</b>	2,5	2,7	1,8	1,6	068-2010	<b>201.18.1502</b>	<b>18,80</b>
<b>02</b>	3,5	3,8	2,6	2,1	068-2015	<b>201.18.1503</b>	<b>18,80</b>
<b>03</b>	5,2	5,6	4,6	4,2	068-2006	<b>201.18.1504</b>	<b>18,80</b>
<b>04</b>	8,0	8,6	6,7	6,0	068-2007	<b>201.18.1505</b>	<b>18,80</b>
<b>05</b>	10,5	11,3	8,6	7,7	068-2008	<b>201.18.1506</b>	<b>18,80</b>
<b>06</b>	15,5	16,7	10,5	9,1	068-2009	<b>201.18.1507</b>	<b>18,80</b>

Menovitý výkon pre:  $t_e = +5^\circ\text{C}$  na rozsah N, resp.  $t_e = -30^\circ\text{C}$  na B rozsah,  $t_e = +32^\circ\text{C}$ , teplota kvapaliny pred ventilom:  $t_f = +28^\circ\text{C}$ .

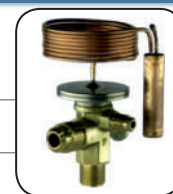

## Termostatické expanzné ventily TIS / TISE

Skrutkovací x skrutkovací prípoj

Chladivo	Typ	Vyrovnávanie	Kapilára	Prípoj		Kód Alco / DTN obj. číslo / Cena bez DPH					
				Vstup / Výstup		-45 - +20°C	-45 - 0°C	-45 - +10°C	-45 - +12°C	-45 - -3°C	-45 - -27°C
				m	in. x in.	mm x mm	Bez MOP	MOP +10°C	MOP +14°C	MOP +15°C	MOP 0°C
R22	TIS-HW	-	1,50	5/8"x1/2"	16x12	802422					
						201.04.1085					
					44,30						
	TISE-HW TISE-HW100	1/4"	1,50	5/8"x1/2"	16x12	802423			802431		
201.04.1090								201.04.1095			
								69,70			
R407C	TIS-NW	-	1,50	5/8"x1/2"	16x12	802437					
						201.04.1100					
					44,30						
	TISE-NW	1/4"	1,50	5/8"x1/2"	16x12	802438					
201.04.1105											
								69,70			
R134a	TIS-MW	-	1,50	5/8"x1/2"	16x12	802447					
						201.04.1130					
					44,30						
	TISE-MW TISE-MW55	1/4"	1,50	5/8"x1/2"	16x12	802448		802457			
201.04.1135							201.04.1080				
								69,70			
R404A R507	TIS-SW TIS-SAD-10	-	1,50	5/8"x1/2"	16x12	802461	802478				
						201.04.1110	201.04.1150				
					44,30	44,30					
	TISE-SW TISE-SAD-10 TISE-SW75 TISE-SAD-20	1/4"	1,50	5/8"x1/2"	16x12	802462	802479		802471	802474	
201.04.1115						201.04.1155		201.04.1125	201.04.1120		
								69,70	69,70		

EXPANZNÉ VENTILY TIS / TISE

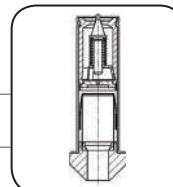

## Dýzy

Termostatické Expanzné Ventily TIS, TISE

Dýza	Rozsah : -45°C až + 20°C				Obj. číslo ALCO	Obj. číslo DTN	Cena v EUR bez DPH	
	Výkon v kW							Skrutkovacia verzia
	R22	R407C	R134a	R404A R507				
TIO-00X	0,5	0,5	0,3	0,4	800 532	201.04.1500	15,40	
TIO-000	1,3	1,4	0,8	1,0	800 533	201.04.1505	15,40	
TIO-001	3,2	3,5	1,9	2,3	800 534	201.04.1510	15,40	
TIO-002	5,3	5,7	3,1	3,9	800 535	201.04.1515	15,40	
TIO-003	8,5	9,2	5,0	6,2	800 536	201.04.1520	15,40	
TIO-004	13,9	15,0	8,3	10,1	800 537	201.04.1525	15,40	
TIO-005	16,9	18,3	10,1	12,3	800 538	201.04.1530	15,40	
TIO-006	19,5	21,1	11,7	14,2	800 539	201.04.1535	15,40	

Výkony sú počítané pri  $t_0 = +4^\circ\text{C}$  a  $t_c = +38^\circ\text{C}$  a 1 K podchladenia kvapaliny vstupujúcej do ventilu

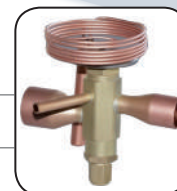

## Navárací x navárací prípoj

Termostatické Expanzné Ventily TX7 pre R410A / R32 s pevne zabudovanou dýzou

Chladivo	Typ	Vyrovna- vanie	Kapilára m	Prípoje	Výkon v kW pre R410A	Obj. číslo ALCO	Obj. číslo DTN	Cena v EUR bez DPH
				Vstup / Výstup	Rozsah: -40°C až +14°C			
				mm x mm	MOP+20°C			
R410A / R32	TX7-Z13	6mm	1,50	12x16	32,1	806 811	201.04.9020	129,-
	TX7-Z14	6mm	1,50	16x22	39,9	806 813	201.04.9025	158,30
	TX7-Z15	6mm	1,50	16x22	48,9	806 815	201.04.9030	158,30
	TX7-Z16	6mm	1,50	22x28	80,7	806 817	201.04.9035	158,30
	TX7-Z17	6mm	1,50	22x28	99,4	806 819	201.04.9040	158,30
	TX7-Z18	6mm	1,50	22x28	130,9	806 821	201.04.9045	238,50
	TX7-Z19	6mm	1,50	22x28	183,4	806 823	201.04.9050	238,50

Výkony sú počítané pri  $t_o = +4^\circ\text{C}$  a  $t_c = +38^\circ\text{C}$  a 1 K podchladenia kvapaliny vstupujúcej do ventilu

## Honeywell



### Termostatické expanzné ventily TMV, TMVX

Chla- divo	Typ	Vyrovna- vanie	Kapi- lára m	Prípoj Vstup x Výstup in x in.	Kód Honeywell / DTN obj. číslo / Cena bez DPH					
					Rozsah: -50°C - +15°C	Rozsah: -45°C - +5°C	Rozsah: -50°C - -10°C	Rozsah: -50°C - -20°C	Rozsah: -50°C - -27°C	
					Bez MOP	MOP +15°C	MOP 0°C	MOP -10°C	MOP -18°C	
R22 / R407C	TMV	-	1,50	5/8" x 3/4"	TMV-00001	TMV-00004	TMV-00003		TMV-00002	
					201.36.9005	201.36.9006	201.36.9007		201.36.9008	
						45,84	45,84	45,84	45,84	
	TMVX	1/4"	1,50	5/8" x 3/4"	TMVX-00101	TMVX-00104	TMVX-00103		TMVX-00102	
201.36.9035					201.36.9036	201.36.9037		201.36.9038		
					68,85	68,85	68,85	68,85		
R134a	TMV	-	1,50	5/8" x 3/4"	TMV-00005	TMV-00007	TMV-00006			
					201.36.9010	201.36.9011	201.36.9012			
						45,84	45,84	45,84		
	TMVX	1/4"	1,50	5/8" x 3/4"	TMVX-00105	TMVX-00107	TMVX-00106			
201.36.9040					201.36.9041	201.36.9042				
					68,85	68,85	68,85			
R404A R507	TMV	-	1,50	5/8" x 3/4"	TMV-00008	TMV-00012		TMV-00011	TMV-00010	TMV-00009
					201.36.9015	201.36.9025		201.36.9026	201.36.9027	201.36.9020
						45,84	45,84	45,84	45,84	
	TMVX	1/4"	1,50	5/8" x 3/4"	TMVX-00108	TMVX-00112		TMVX-00111	TMVX-00110	TMVX-00109
201.36.9000					201.36.9001		201.36.9002	201.36.9003	201.36.9004	
					68,85	68,85	68,85	68,85	68,85	

### Dýzy Honeywell

Číslo dýzy	N rozsah: -40 - +10°C				Kód Honeywell	DTN obj. číslo	Cena bez DPH
	Menovitý výkon (kW)						
	R134a	R22	R407C	R404A			
VD 0,3	0.36	0.52	0.50	0.36	TMVD-00010	201.36.9101	15,30
VD 0,5	0.69	0.99	0.95	0.69	TMVD-00008	201.36.9102	15,30
VD 0,7	1,0	1,4	1,3	0,97	TMVD-00009	201.36.9103	15,30
VD 1,0	1,4	2,0	1,9	1,4	TMVD-00001	201.36.9104	15,30
VD 1,5	2,2	3,2	3,1	2,2	TMVD-00002	201.36.9105	15,30
VD 2,0	2,9	4,0	3,9	2,8	TMVD-00003	201.36.9002	15,30
VD 2,5	4,0	5,8	5,6	4,1	TMVD-00004	201.36.9003	15,30
VD 3,0	6,6	9,3	8,9	6,5	TMVD-00005	201.36.9106	15,30
VD 3,5	8,7	12,2	11,7	8,6	TMVD-00006	201.36.9107	15,30
VD 4,5	11,8	17,0	16,4	12,0	TMVD-00007	201.36.9108	15,30
VD 4,75	15,9	22,4	21,6	15,8	TMVD-00011	201.36.9004	15,30



Termostatické expanzné ventily T

Zaradenie	R22		R134a		R404A		R407C		Dýza			Cena bez DPH	Vrchný diel	Spodný diel navárací			Cena bez DPH
	Typ	Men. výk.	Typ	Men. výk.	Typ	Men. výk.	Typ	Men. výk.	Typ	Obj. Alco	DTN obj. číslo			vstup x výstup ODF (mm)	Obj. Alco	DTN obj. číslo	
TCLE	50 HW	1,9	25 MW	1,5	25 SW	1,3	50 NW	2,1	X 22440-B1B	803210	201.04.2500	65,-	XB1019	C 501 - 5 MM 10 X 16	803233	201.04.2600	29,50
	100 HW	3,7	75 MW	2,9	75 SW	2,6	100 NW	4,0	X 22440-B2B	803211	201.04.2505	65,-					
	200 HW	7,9	150 MW	6,1	150 SW	5,6	200 NW	8,5	X 22440-B3B	803212	201.04.2510	65,-					
	250 HW	11,9	200 MW	9,3	200 SW	8,4	300 NW	12,9	X 22440-B3,5B	803462	201.04.2515	65,-					
	300 HW	17,3	250 MW	13,5	250 SW	12,2	400 NW	18,7	X 22440-B4B	803213	201.04.2520	65,-					
	500 HW	22,2	350 MW	17,3	400 SW	15,7	550 NW	24,0	X 22440-B5B	803214	201.04.2525	65,-					
	750 HW	30,4	550 MW	23,6	600 SW	21,5	750 NW	32,9	X 22440-B6B	803215	201.04.2530	65,-					
	1000 HW	41,1	750 MW	32,0	850 SW	29,0	1000 NW	44,4	X 22440-B7B	803216	201.04.2535	65,-					
TJRE	14 HW	58,0	11 MW	45,0	12 SW	40,0	14 NW	62,0	X 11873-B4B	803348	201.04.2545	160,20	XC726	A 576 MM 16 X 22 (22 X 28 ODM)	803239	201.04.2610	45,20
	18 HW	74,0	13 MW	57,0	14 SW	51,0	17 NW	80,0	X 11873-B5B	803349	201.04.2550	160,20					
TERE	22 HW	91,0	16 MW	71,0	18 SW	63,0	21 NW	99,0	X 91117-B6B	803341	201.04.2555	167,70	XC726	9153 MM 22 X 22	803245	201.04.2620	65,20
	26 HW	104,0	19 MW	81,0	20 SW	72,0	25 NW	112,0	X 91117-B7B	803342	201.04.2560	167,70					
	35 HW	143,0	25 MW	112,0	27 SW	99,0	33 NW	155,0	X 91117-B8B	803343	201.04.2565	167,70					
	45 HW	174,0	31 MW	135,0	34 SW	120,0	42 NW	188,0	X 91117-B9B	803344	201.04.2170	167,70					
TIRE	55 HW	223,0	45 MW	174,0	47 SW	154,0	52 NW	241,0	X 9166-B10B	803347	201.04.2175	234,90	XC726	9149 22 X 22	803284	201.04.2625	65,20
THRE	75 HW	253,0	55 MW	197,0	61 SW	174,0	71 NW	273,0	X 9144-B11B	803345	201.04.2180	367,20					
	100 HW	302,0	68 MW	236,0	77 SW	209,0	94 NW	327,0	X 9144-B13B	803346	201.04.2185	367,20					

Vrchný diel						Vrchný diel					
XB 1019 kapilára 1,5 m						XC 726 kapilára 3 m					
Vrchný diel		Chladivo	Najvyššia teplota	DTN obj. číslo	Cena bez DPH	Vrchný diel		Chladivo	Najvyššia teplota	DTN obj. číslo	Cena bez DPH
Typ	Obj. Alco					Typ	Obj. Alco				
XB 1019 HW -1B	802931	R22	-	201.04.2000	116,-	XC 726 HW -2B	802933	R22	-	201.04.2065	231,-
XB 1019 HW 100-1B	803043		± 13	201.04.2005	116,-	XC 726 HW 100-2B	803070		± 13	201.04.2070	231,-
XB 1019 HW 65-1B	803039		± 0	201.04.2010	116,-	XC 726 HW 65-2B	803067		± 0	201.04.2075	231,-
XB 1019 HW 35-1B	803035		- 16	201.04.2015	116,-	XC 726 HW 35-2B	803065		- 16	201.04.2080	231,-
XB 1019 MW -1B	802947	R134a	-	201.04.2020	116,-	XC 726 MW -2B	803384	R134a	-	201.04.2085	231,-
XB 1019 MW 55-1B	803379		+ 11	201.04.2025	116,-	XC 726 MW 55-2B	803391		+ 11	201.04.2090	231,-
XB 1019 MW 35-1B	803381		± 0	201.04.2030	116,-	XC 726 MW 35-2B	803436		± 0	201.04.2095	231,-
XB 1019 SW -1B	803443	R404A	-	201.04.2035	116,-	XC 726 SW -2B	803451	R404A	-	201.04.2100	231,-
XB 1019 SW 80-1B	803454		± 0	201.04.2040	116,-	XC 726 SW 80-2B	803457		± 0	201.04.2105	231,-
XB 1019 SW 55-1B	803474		- 10	201.04.2045	116,-	XC 726 SW 55-2B	803476		- 10	201.04.2110	231,-
XB 1019 SW 40-1B	803452	R507	- 18	201.04.2050	116,-	XC 726 SW 40-2B	803456	R507	- 18	201.04.2115	231,-
XB 1019 NW -1B	803480		-	201.04.2055	116,-	XC 726 NW -2B	803484		-	201.04.2120	231,-
XB 1019 NW 100-1B	803482		- 14	201.04.2060	116,-	XC 726 NW 100-2B	803485		- 14	201.04.2125	231,-

Príslušenstvo			
Typ	Obj. Alco	Popis	DTN obj. číslo
X 13455-1	027579	Tesniaci set pre dýzy	☎

EXPANZNÉ VENTILY



Filterdehydrátory tlačné DE.NA

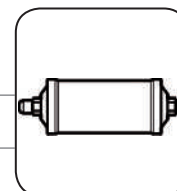

Typ	Vstup / Výstup	DE.NA kód	DTN obj. číslo	Cena bez DPH	Pájkovací		Skrutkovací		Cena bez DPH
					Vstup / Výstup	DE.NA kód	DTN obj. číslo	Cena bez DPH	
MG111	6mm	ODS 032	203.19.1000	6,-	1/4"	SAE 032	203.19.2000	6,-	
MG112	6mm	ODS 052	203.19.1005	7,40	1/4"	SAE 052	203.19.2005	7,40	
MG122	10mm	ODS 053	203.19.1010	8,30	3/8"	SAE 053	203.19.2010	8,30	
MG213	6mm	ODS 082	203.19.1015	9,20	1/4"	SAE 082	203.19.2015	9,20	
MG223	10mm	ODS 083	203.19.1020	10,40	3/8"	SAE 083	203.19.2020	10,40	
MG233	12mm	ODS 084	203.19.1025	11,80	1/2"	SAE 084	203.19.2025	11,80	
MG214	6mm	ODS 162	203.19.1030	11,80					
MG224	10mm	ODS 163	203.19.1035	13,70	3/8"	SAE 163	203.19.2035	13,70	
MG234	12mm	ODS 164	203.19.1040	14,50	1/2"	SAE 164	203.19.2040	14,50	
MG244	16mm	ODS 165	203.19.1045	16,-	5/8"	SAE 165	203.19.2045	16,-	
MG325	10mm	ODS 303	203.19.1050	16,-					
MG335	12mm	ODS 304	203.19.1055	28,-	1/2"	SAE 304	203.19.2055	28,-	
MG336	12mm	ODS 414	203.19.1060	28,-					
MG345	16mm	ODS 305	203.19.1065	28,80	5/8"	SAE 305	203.19.2060	28,80	
MG355	18mm	ODS 307	203.19.1070	34,50	3/4"	SAE 307	203.19.2065	34,50	
MG346	16mm	ODS 415	203.19.1075	32,10	5/8"	SAE 415	203.19.2070	32,10	



Filterdehydrátory sacie DE.NA

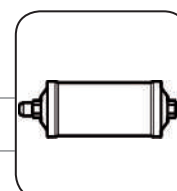

Typ	Vstup / Výstup	DE.NA kód	DTN obj. číslo	Cena bez DPH	Pájkovací		Skrutkovací		Cena bez DPH
					Vstup / Výstup	DE.NA kód	DTN obj. číslo	Cena bez DPH	
MG224/SC	10mm	ODS 163	203.19.3000	23,80	3/8"	SAE 163	203.19.3100	23,80	
MG234/SC	12mm	ODS 164	203.19.3005	24,-	1/2"	SAE 164	203.19.3105	24,-	
MG244/SC	16mm	ODS 165	203.19.3010	25,30	5/8"	SAE 165	203.19.3110	25,30	
MG345/SC	16mm	ODS 305	203.19.3015	42,-	5/8"	SAE 305	203.19.3115	42,-	
MG355/SC	18mm	ODS 416	203.19.3025	42,-	3/4"	SAE 416	203.19.3120	42,-	
MG366/SC	22mm	ODS 417	203.19.3030	42,-	7/8"	SAE 417	203.19.3125	42,-	



Filterdehydrátory pre domáce chladenie DE.NA

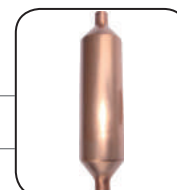

Typ	Vstup	Výstup	Prevedenie	DTN obj. číslo	Cena bez DPH
	Pájkovací				
8gr.	5mm	2,5mm	2 cestný	203.19.5065	0,75
10gr.	5mm	2,7mm	2 cestný	203.19.5000	0,75
15gr.	6mm	2,7mm	2 cestný	203.19.5005	0,90
20gr.	6mm	2,7mm	2 cestný	203.19.5010	1,10
30gr.	6mm	6mm	2 cestný	203.19.5020	1,65
30gr.	6mm	2,7mm	2 cestný	203.19.5015	1,65
50gr.	6mm	6mm	2 cestný	203.19.5025	2,10
10gr.	6mm, 6mm	2,5mm	3 cestný	203.19.5055	0,75
15gr.	6mm, 6mm	2,5mm	3 cestný	203.19.5030	1,-
20gr.	6mm, 6mm	2,5mm	3 cestný	203.19.5035	1,10
30gr.	6mm, 6mm	6mm	3 cestný	203.19.5040	1,65
40gr.	6mm, 6mm	6mm	3 cestný	203.19.5045	1,95
50gr.	6mm, 6mm	6mm	3 cestný	203.19.5050	2,10





## Filterdehydrátory tlačné KMP



Nový typ	DTN obj. číslo	Starý typ	DTN obj. číslo	Prípoj		Cena bez DPH
				Pájkovací	Skrutkovací	
PR032	203.43.2000	WEU 032 F	203.43.1000		1/4"	11,-
PR0306MMS	203.43.2200	WEU 0306 mmS	203.43.1075	6mm		11,-
PR052	203.43.2010	WEU 052 F	203.43.1005		1/4"	13,82
PR0506MMS	203.43.2205	WEU 0506 mmS	203.43.1080	6mm		13,82
PR053	203.43.2015	WEU 053 F	203.43.1010		3/8"	13,82
PR0510MMS	203.43.2210	WEU 0510 mmS	203.43.1085	10mm		13,82
PR082	203.43.2020	WEU 082 F	203.43.1015		1/4"	17,-
PR0806MMS	203.43.2215	WEU 0806 mmS	203.43.1090	6mm		17,-
PR083	203.43.2025	WEU 083 F	203.43.1020		3/8"	17,-
PR0810MMS	203.43.2220	WEU 0810 mmS	203.43.1095	10mm		17,-
PR084	203.43.2030	WEU 084 F	203.43.1025		1/2"	17,-
PR0812MMS	203.43.2225	WEU 0812 mmS	203.43.1100	12mm		17,-
PR162	203.43.2035	WEU 162 F	203.43.1030		1/4"	21,-
PR1606MMS	203.43.2228	WEU 1606 mmS	203.43.1105	6mm		-
PR163	203.43.2040	WEU 163 F	203.43.1035		3/8"	21,-
PR1610MMS	203.43.2230	WEU 1610 mmS	203.43.1110	10mm		21,-
PR164	203.43.2045	WEU 164 F	203.43.1040		1/2"	21,-
PR1612MMS	203.43.2235	WEU 1612 mmS	203.43.1115	12mm		21,-
PR165	203.43.2050	WEU 165 F	203.43.1045		5/8"	21,-
PR165S	203.43.2145	WEU 165 S	203.43.1135	5/8"		21,-
PR303	203.43.2055	WEU 303 F	203.43.1050		3/8"	36,60
PR304	203.43.2060	WEU 304 F	203.43.1055		1/2"	36,60
PR305	203.43.2065	WEU 305 F	203.43.1060		5/8"	36,60
PR305S	203.43.2160	WEU 305 S	203.43.1140	5/8"		36,60
PR307S	203.43.2165	WEU 307 S	203.43.1145	7/8"		42,-
PR414	203.43.2070	WEU 414 F	203.43.1065		1/2"	64,10
PR415	203.43.2075	WEU 415 F	203.43.1070		5/8"	64,10
PR415S	203.43.2175	WEU 415 S	203.43.1150	5/8"		64,10
PR417S	203.43.2180	WEU 417 S	203.43.1155	7/8"		64,10
PR757S	203.43.2185	WEU 757S	203.43.1175	7/8"		100,10

FILTERDEHYDRÁTORY



## Filterdehydrátory KMP sacie



Nový typ	DTN obj. číslo	Starý typ	DTN obj. číslo	Vstup - Výstup		Cena bez DPH
				Pájkovací		
C-163-S-T-HH	203.43.3140	WSL 163S	203.43.5000	3/8"		
C-164-S-T-HH	203.43.3145	WSL 164S	203.43.5005	1/2"		39,60
C-165-S-T-HH	203.43.3150	WSL 165S	203.43.5010	5/8"		40,40
C-166-S-T-HH	203.43.3155	WSL 166S	203.43.5015	3/4"		41,30
C-167-S-T-HH	203.43.3160	WSL 167S	203.43.5020	7/8"		41,30
C-305-S-T-HH	203.43.3165	WSL 305S	203.43.5025	5/8"		54,60
C-306-S-T-HH	203.43.3170	WSL 306S	203.43.5030	3/4"		65,20
C-307-S-T-HH	203.43.3175	WSL 307S	203.43.5035	7/8"		65,20
C-419-S-T-HH	203.43.3195	WSL 419S	203.43.5040	1-1/8"		93,90
C-4311-S-T-HH	203.43.3210	WSL 7511S	203.43.5045	1-3/8"		149,80
C-4313-S-T-HH	203.43.3215	WSL 7513S	203.43.5050	1-5/8"		151,50



### Filterdehydrátory Danfoss DML s „O“ krúžkom pre transportné chladenie

Typ	Vstup - Výstup		Kód Danfoss	DTN obj. číslo	Cena bez DPH
DML163FS	3/8"	3/8"	023Z0245	203.18.2105	26,30
DML303FS	3/8"	3/8"	023Z0247	203.18.2100	41,70



### Obojsmerné filterdehydrátory Alco pre tepelné čerpadlá

Typ	Vstup - Výstup		Kód Alco	DTN obj. číslo	Cena bez DPH
BFK-052	1/4"(6mm) SAE	1/4"(6mm) SAE	007343	203.04.1000	26,90
BFK-052S	1/4" ODF	1/4" ODF	007344	203.04.1005	26,90
BFK-083	3/8"(10mm) SAE	3/8"(10mm) SAE	007345	203.04.1010	34,10
BFK-083S	3/8" ODF	3/8" ODF	007346	203.04.1015	34,10
BFK-084	1/2"(12mm) SAE	1/2"(12mm) SAE	007347	203.04.1020	34,10
BFK-084S	1/2" ODF	1/2" ODF	007348	203.04.1025	34,10
BFK-163	3/8"(10mm) SAE	3/8"(10mm) SAE	007349	203.04.1030	41,-
BFK-163S	3/8" ODF	3/8" ODF	007350	203.04.1035	41,-
BFK-164	1/2"(12mm) SAE	1/2"(12mm) SAE	007351	203.04.1040	41,-
BFK-164S	1/2" ODF	1/2" ODF	007352	203.04.1045	41,-
BFK-165	5/8"(16mm) SAE	5/8"(16mm) SAE	007353	203.04.1050	41,-
BFK-165S	5/8" ODF	5/8" ODF	007354	203.04.1055	41,-
BFK-305S	5/8"(16mm) SAE	5/8"(16mm) SAE	007356	203.04.1060	51,10
BFK-307S	7/8"(22mm) ODF	7/8"(22mm) ODF	007357	203.04.1065	51,10
BFK-309S	1-1/8" ODF	1-1/8" ODF	007358	203.04.1070	51,10



### Filtračné vložky

Typ	Popis	Kód Danfoss	DTN obj. číslo	Cena bez DPH
48-DM	Keramická vložka Danfoss pre kvapalinu	023U1496	203.18.8000	20,70
48-F	Filcová pevná vložka Danfoss na väčšie nečistoty - sacia	023U1921	203.18.8005	32,90
48-DA	Hliníková vložka Danfoss po vyhorení	023U5380	203.18.8010	37,70
H-48	Hliníková vložka Alco po vyhorení	6969	203.04.8000	25,50



### Domčeky Castel - rozoberateľné filterdehydrátory

Typ	Vstup / Výstup	Počet vložiek	DTN obj. číslo	Cena bez DPH
	Pájkovací			
4411/5A	16mm	1	203.14.1000	81,60
4411/7A	22mm	1	203.14.1005	81,60
4411/9A	28mm	1	203.14.1010	83,90
4411/11A	35mm	1	203.14.1015	85,40
4411/M42A	42mm	1	203.14.1020	88,40
4411/17A	54mm	1	203.14.1025	92,20
4412/7A	22mm	2	203.14.1035	105,80
4412/9A	28mm	2	203.14.1040	97,50
4412/11A	35mm	2	203.14.1045	99,-
4412/M42A	42mm	2	203.14.1050	113,40
4412/17A	54mm	2	203.14.1055	117,60
4413/11A	35mm	3	203.14.1070	131,-
4413/M42A	42mm	3	203.14.1075	134,40
4414/M42A	42mm	4	203.14.1085	155,40
4414/17A	54mm	4	203.14.1090	159,50



### Priehľadítka pájkovacie

Typ	Pripoje ODF Ø d		Max. tlak [bar]	Cena bez DPH Eur
	[Zoll]	[mm]		
SYJ06H12	1/4"	6	46	9,28
SYJ10H12	3/8"	10		9,62
SYJ12H12	1/2"	12		11,86
SYJ16H11	5/8"	16		12,48
SYJ22H11	7/8"	22		17,92



### Priehľadítka skrutkovacie

Typ	Pripoje SAE Ø d	Max. tlak [bar]	Cena bez DPH Eur
	[.]		
SYJ06L11	1/4"	46	9,02
SYJ10L11	3/8"		9,02
SYJ12L11	1/2"		11,28
SYJ16L11	5/8"		11,90



### Priehľadítka skrutkovacie M/F

Typ	Pripoje SAE Ø d	Max. tlak [bar]	Cena bez DPH Eur
	[.]		
SYJ06L41	1/4"	46	9,02
SYJ10L41	3/8"		9,02
SYJ12L41	1/2"		11,28
SYJ16L41	5/8"		11,90

PRIEHLADITKA PÁJKOVACIE



**Magnetické ventily skrutkovacie, NO, bez cievky**

Typ	Pripoje [mm]	Kv [m <sup>3</sup> /h]	Teplota média [°C]	Otváranie	Min. otvárací tlak [bar]	Max. otvárací tlak [bar]		Max. tlak [bar]	Cena bez DPH						
						AC	DC		Eur						
MDF-A03-2H003	6	0,16	-30 až +105	Magnet	0	31	21	45	13,36						
MDF-A03-3H005		0,23							13,36						
MDF-A03-3H007		0,23							13,36						
MDF-A03-6H005	10	0,8		18,32											
MDF-A03-6H007		0,8		18,32											
MDF-A03-10H005		0,8		28,88											
MDF-A03-15H005	12	2,3		Servo	0,1	31	21	45	34,68						
MDF-A03-10H003		1,9							28,88						
MDF-A03-15H003		2,3							34,70						
MDF-A03-20H001	22	5,0							-40 až +140	Pilot	0,2	31	21	45	93,52
MDF-A03-22H001		5,9													99,44
MDF-A03-20H007		5,0													93,52
MDF-A03-22H011	28	5,9	Pilot	0,2	31	21	45	99,44							
MDF-A03-22H003		5,9						99,44							
MDF-B03-25H005		10,0						104,70							
MDF-B03-25H004	35	10,0						Pilot		0,2	31	21	45	104,70	
MDF-B03-32H001		15												214,48	
MDF-B03-32H003		15												214,48	
MDF-B03-40H003	42	25	Pilot	0,2	31	21	45							218,18	
MDF-B03-40H004		25												218,18	

MAGNETICKÉ VENTILY

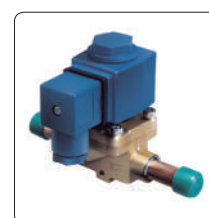

**Magnetické ventily spájkovacie, NO, bez cievky**

Typ	Pripoje [mm]	Kv [m <sup>3</sup> /h]	Otváranie	Min. otvárací tlak	Max. otvárací tlak		Teplota média [°C]	Max. tlak [bar]	Cena bez DPH				
					AC [bar]	DC [bar]			Eur				
MDF-A03-2L001	1/4"	0,16	Magnet	0	31	21	-30 až +105	45	12,74				
MDF-A03-3L001	1/4"	0,23							12,74				
MDF-A03-3L003	3/8"	0,23							12,74				
MDF-A03-6L001	3/8"	0,8	Servo	0,1					31	21	-30 až +105	45	17,46
MDF-A03-6L003	1/2"	0,8											17,46
MDF-A03-10L003	1/2"	1,9											27,50
MDF-A03-10L001	5/8"	1,9			27,50								
MDF-A03-15L001	5/8"	2,3			33,04								
MDF-A03-15L003	7/8"	2,3			33,04								

**Cievky pre magnetické ventily**

Typ	Voltáž	Napájanie	Príkon [W]	Frekvencia [Hz]	Krytie	Trieda ochrany	Pripoj	Cena bez DPH
	[V]							Eur
MQ-D03024-000002	24	AC	15	50 / 60	IP65	F	DIN konektor	9,28
MQ-A11024-000001	24		9,5 / 8,5		IP67			15,20
MQ-A1122G-000001	220 - 240		11,0 / 9,5		IP67			15,20
MQ-A03024-000001	24		10,5 / 8,5		IP65			9,28
MQ-A0322G-000001	220 - 240		12 / 10		IP65			9,28



## Guľové ventily s plniacim ventilom

Typ	Vstup/výstup ODF	Kv-hodnota	Maximálny tlak	Teplota média	Plniaci ventil	Cena bez DPH
	Ø D					
	[mm]	[m <sup>3</sup> /h]	[bar]	°C	Eur	
SBV(M)-JA2YHSY-2-S	6	1,9	45	od -40 do +120	Áno	15,46
SBV(M)-JA3YHSY-1-S	10	5,5				15,46
SBV(M)-JA4YHSY-2-S	12	10,2				15,94
SBV(M)-JA5YHSY-1-S	16	13,8				15,94
SBV(M)-JA6YHSY-2-S	18	19,5				23,14
SBV(M)-JA7YHSY-1-S	22	28,0				24,96
SBV(M)-JA9YHSY-2-S	28	51,5				34,68
SBV(M)-JA11YHSY-1-S	35	80,0				62,32
SBV(M)-JA13YHSY-1-S	42	119,8				73,46
SBV(M)-JA17YHSY-1-S	54	225				127,88
SBV(M)-JA19YHSY-1-S	64	225				127,88
SBV(M)-JA25YHSY-2-S	80	635				259,82
SBV(M)-JA29YHSY-1-S	92	805				355,14
SBV(M)-JA33YHSY-2-S	105	950				564,94
SBV(M)-JA34YHSY-1-S	108	950	564,94			

GUĽOVÉ VENTILY



**Guľové ventily KMP**



Prípoj	Kód KMP	DTN obj. číslo	Cena bez DPH
D 6	OBV6mm	206.71.1000	25,40
D 10	OBV10mm	206.71.1005	25,40
D 12	OBV12mm	206.71.1010	27,80
D 15	OBV15mm	206.71.1015	31,20
D 16	OBV5	206.71.1020	31,20
D 18	OBV18mm	206.71.1025	34,60
D 22	OBV22mm	206.71.1030	44,90
D 28	OBV28mm	206.71.1035	58,80
D 35	OBV11	206.71.1040	80,70
D 42	OBV42mm	206.71.1045	111,80
D 54	OBV17	206.71.1050	164,50
D 64	BV64mm	206.71.1055	211,60
D 76	BV76mm	206.71.1060	502,90
D 89	BV89mm	206.71.1065	557,-
D 108	BV108mm	206.71.1070	658,60



**Guľové ventily Castel - s plniacim ventilom 1/4" SAE**

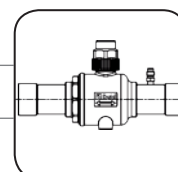

Prípoj	Kód Castel	DTN obj. číslo	Cena bez DPH
6mm	6570/M6	206.14.1000	25,05
10mm	6570/M10A	206.14.1015	25,80
12mm	6570/M12A	206.14.1020	25,80
15mm	6570/M15A	206.14.1035	-
16mm	6570/5A	206.14.1040	33,10
18mm	6570/M18A	206.14.1045	34,-
22mm	6570/7A	206.14.1060	43,-
28mm	6570/M28A	206.14.1075	54,50
35mm	6590/11A	206.14.1090	77,50
42mm	6590/M42A	206.14.1110	115,10
54mm	6590/17A	206.14.1120	165,-
64mm	6591/M64A	206.14.1220	169,10



**Priehľadítka Castel s pájkovacím prípojom**

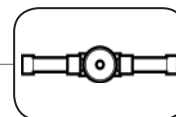

Typ	Prípoj		Castel kód	DTN obj. číslo	Cena bez DPH
	mm	in.			
3940/2	6	1/4"	3940/2	204.14.1100	14,70
3940/M10	10	3/8"	3940/M10	204.14.1105	15,90
3940/M12	12	1/2"	3940/M12	204.14.1110	16,60
3940/5	16	5/8"	3940/5	204.14.1115	18,30
3940/M18	18	3/4"	3940/M18	204.14.1120	22,-
3940/7	22	7/8"	3940/7	204.14.1125	30,20
3940/9	28	1-1/8"	3940/9	204.14.1130	36,60



**Priehľadítka Honeywell s pájkovacím prípojom**

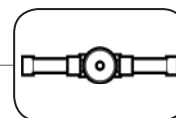

Typ	Prípoj		Honeywell kód	DTN obj. číslo	Cena bez DPH
	vstup	výstup			
SLI6	6	6	SLI-01001	204.36.1105	23,41
SLI10	10	10	SLI-01003	204.36.1110	23,91
SLI12	12	12	SLI-01005	204.36.1115	27,62
SLI16	16	16	SLI-01008	204.36.1120	30,10
SLI18	18	18	SLI-01010	204.36.1125	38,21
SLI22	22	22	SLI-01011	204.36.1130	47,28

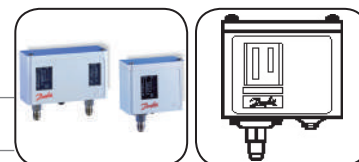
### Presostaty Danfoss (nizky tlak)

Typ	Nastaviteľný rozsah	Reset	Prípoj	Kód Danfoss	DTN obj. číslo	Cena bez DPH
	bar					
KP1	-0,9 - 7,0	manuálny	1/4" skrutkovací	060-110366	208.18.1005	61,40
KP1	-0,9 - 7,0	manuálny	6 mm pájkovací	060-110966	208.18.1105	61,40
KP1	-0,2 - 7,5	auto	1/4" skrutkovací	060-110166	208.18.1000	57,50
KP1	-0,2 - 7,5	auto	6 mm pájkovací	060-111066	208.18.1100	57,50
KP2	-0,2 - 5,0	auto	1/4" skrutkovací	060-112066	208.18.1010	57,50
KP2	-0,2 - 5,0	auto	6 mm pájkovací	060-112366	208.18.1110	57,50

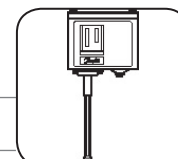

### Presostaty Danfoss (vysoký tlak)

Typ	Nastaviteľný rozsah	Reset	Prípoj	Kód Danfoss	DTN obj. číslo	Cena bez DPH
	bar					
KP5	8 - 32	auto	1/4" skrutkovací	060-117166	208.18.1015	57,50
KP5	8 - 32	auto	6 mm pájkovací	060-117766	208.18.1115	57,50
KP6B	8 - 42	manuálny	1/4" skrutkovací	060-519166	208.18.1030	57,-
KP6W	8 - 42	auto	1/4" skrutkovací	060-519066	208.18.1025	81,30
KP7B	8 - 32	manuálny	1/4" skrutkovací	060-119166	208.18.1040	81,30
KP7W	8 - 32	auto	1/4" skrutkovací	060-119066	208.18.1035	74,60
KP7W	8 - 32	auto	6 mm pájkovací	060-120366	208.18.1125	74,60

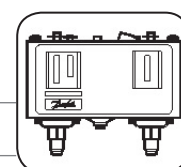

### Presostaty Danfoss kombinované

Typ	Nastaviteľný rozsah bar	Reset		Prípoj	Kód Danfoss	DTN obj. číslo	Cena bez DPH
		ľavá strana	pravá strana				
KP7BS	8 - 32	manuálny	manuálny	1/4" skrutkovací	060-120066	208.18.1045	115,-
KP15	-0,2 - 7,5 / 8 - 32	auto	auto	1/4" pájkovací	060-125466	208.18.1075	109,-
KP15	-0,2 - 7,5 / 8 - 32	auto	manuálny	1/4" skrutkovací	060-126466	208.18.1070	116,-
KP15	-0,2 - 7,5 / 8 - 32	auto	auto	1/4" skrutkovací	060-124166	208.18.1050	102,18
KP17B	-0,2 - 7,5 / 8 - 32	auto	manuálny	1/4" skrutkovací	060-126866	208.18.1085	107,-
KP17B	-0,2 - 7,5 / 8 - 32	auto	manuálny	6 mm pájkovací	060-127466	208.18.1135	107,-
KP17W	-0,2 - 7,5 / 8 - 32	manuálny	auto	1/4" skrutkovací	060-127566	208.18.1080	90,54
KP17W	-0,2 - 7,5 / 8 - 32	auto	auto	6 mm pájkovací	060-127666	208.18.1130	90,54
KP17WB	-0,2 - 7,5 / 8 - 32	nastaviteľný		1/4" skrutkovací	060-539766	208.18.1090	90,54

### Konzola na presostaty

Typ	Kód Danfoss	DTN obj. číslo	Cena bez DPH
Konzola na presostat	060-105666	208.18.8000	5,20



### Presostaty RANCO (vrátane montážnej konzoly)

Typ	Nastaviteľný rozsah [bar]	Reset		Prípoj	Obj. kód DTN	Cena bez DPH
		ľavá strana	pravá strana			
O17-H4701	7 - 30 / -0,3 - 7	auto	auto	1/4" skrutkovací	208.45.1200	62,-
O16-H6750	7 - 30	auto		1/4" skrutkovací	208.45.1100	37,-
O16-H6751	7 - 30	manuál		1/4" skrutkovací	208.45.1105	37,-

### Mini presostaty

Typ	Otvorenie [PSI/bar]	Zatvorenie [PSI/bar]	Popis	DTN obj. číslo	Cena bez DPH
LPS0520	5 / 0,34	20 / 1,38	nízky tlak	208.40.1000	13,20
LPS2550	25 / 1,72	50 / 3,44	nízky tlak	208.40.1005	6,60
HPS250150	250 / 17,23	150 / 10,3	vysoký tlak	208.40.1100	13,20
HPS350250	350 / 24,13	250 / 17,23	vysoký tlak	208.40.1105	6,60
HPS400300	400 / 27,58	300 / 20,68	vysoký tlak	208.40.1110	6,60



### Rohové ventily pre klimatizácie

Typ	Vstup [mm]	Výstup [zoll]	DTN obj. číslo	Cena bez DPH
Tecnosystemi 11135030	6	1/4"	206.53.1000	13,40
SCV-1501			206.40.1000	13,40
Tecnosystemi 11135031	10	3/8"	206.53.1005	18,40
SCV-1502			206.40.1005	18,40
Tecnosystemi 11135032	12	1/2"	206.53.1010	23,30
SCV-1503			206.40.1010	23,30
Tecnosystemi 11135033	16	5/8"	206.53.1015	31,90
SCV-1504			206.40.1015	31,90

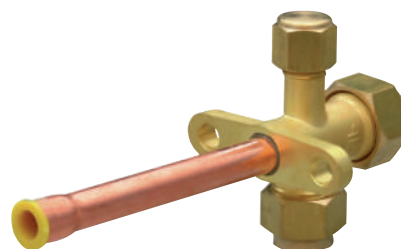

MINI PRESOSTATY

### 4 cestné ventily

Typ	Vstup [zoll]	Výstup [zoll]	DTN obj. číslo	Cena bez DPH
DSF-4	5/16"	3/8"	213.40.1000	26,10
DSF-9	3/8"	1/2"	213.40.1005	31,20
DSF-11	1/2"	5/8"	213.40.1010	34,10
DSF-20	1/2"	3/4"	213.40.1015	72,62
SW-01 cievka	-	-	213.40.8000	10,75





# Elektronické komponenty





## Digitálne termostaty

Typ	Počet relátok a ich funkcia [ks]	Typ sondy	Napájanie [V]	Obj. číslo DTN	Cena v EUR bez DPH
IDPlus 902	1 relé: kompresor (časové odmrazovanie) alebo elektrické kúrenie	NTC/PTC/PT1000; 8A; DI/AI	230	211.24.9055	38,00
IDPlus 961	1 relé: kompresor (časové odmrazovanie) alebo elektrické kúrenie	NTC/PTC/PT1000; 2HP; DI/AI	230	211.24.9003	39,20
IDPlus 961	1 relé: kompresor (časové odmrazovanie) alebo elektrické kúrenie	NTC/PTC/PT1000; 2HP; DI/AI	12	211.24.9060	40,00
IDPlus 971	2 relé: kompresor a odmrazovanie	2xNTC/PTC/PT1000; 2HP/8A; DI; DI/AI	230	211.24.9006	48,80
IDPlus 971	2 relé: kompresor a odmrazovanie	2xNTC/PTC/PT1000; 2HP/8A; DI; DI/AI	12	211.24.9065	58,48
IDPlus 974	3 relé: kompresor, odmrazovanie a ventilátor	2xNTC/PTC/PT1000; 2HP/8/5A; DI; DI/AI; HACCP	230	211.24.9004	51,30
IDPlus 974	3 relé: kompresor, odmrazovanie a ventilátor	2xNTC/PTC/PT1000; 2HP/8/5A; DI; DI/AI; HACCP	12	211.24.9070	63,00
ID 985LX/CK (Televis cez Bus Adaptér)	4 relé: kompresor, odmrazovanie, ventilátor a alarm, Reálny čas, LINK	3xNTC/PTC; 8/8/8/5A; 2xDI	12	211.24.9010	66,50
EWDR 984	3 relé: kompresor, odmrazovanie, ventilátor a pomocný analógový výstup	3xNTC/PTC; 16/8/8A; AO 12V.../20mA; 2xDI	230	211.24.9001	81,00
EWDR 985/CS RS485 (Televis priamo)	4 relé: kompresor, odmrazovanie, ventilátor, svetlo a pomocný analógový výstup, RTC	3xNTC/PTC; 15/8/8/8A; AO 12V.../20mA; 2xDI; BUZZER	230	211.24.9080	125,00



## Regulátor otáčok ventilátora

Typ	Pracovný rozsah	Sonda	Menovité napätie [V]	DTN obj. kód	Cena bez DPH
FASEC 33	0 °C - +60 °C	PTC; 0...60°C; 2,5A triac	230	211.24.7010	44,60

## Sondy

Typ	Eliwell kód	DTN obj. kód	Cena bez DPH
NTC	NTC 1,5MT TPE IP67	211.24.8140	3,00
PTC	PTC 1,5MT IP68	211.24.8145	4,50

## Regulátor otáčok ventilátora Danfoss pre ventilátory kondenzátora

Typ	Pre chladivá	Rozsah nastavenia [bar]	Napájanie [V]	DTN obj. kód Danfoss kód	Cena bez DPH
XGE-4C	R22, R134a, R404A, R407C, R410A	10 - 25	230	211.24.7010	105,06





## Ovládacie rozvádzače PEGO - kompaktné rozmery, vrátane regulátora

Typ	Popis	Rozsah motorového spúšťača kompresora [A]	Men. nap.[V]	DTN obj. kód	Cena bez DPH
ECP 200 Expert	Regulácia a ovládanie 1 fázového kompresora, odmrazovacích telies, ventilátorov výparníka a osvetlenia chladiacej miestnosti. Pomocné/signálne relé	16	230	211.44.2105	180,00
ECP 300 Expert VD4	Regulácia a ovládanie 3 fázového kompresora, 3 fázových odmrazovacích telies, ventilátorov výparníka a osvetlenia chladiacej miestnosti.	9 - 12	380	211.44.2110	530,00
ECP 300 Expert VD7	Regulácia a ovládanie 3 fázového kompresora, 3 fázových odmrazovacích telies, ventilátorov výparníka a osvetlenia chladiacej miestnosti.	14 - 20	380	211.44.2115	664,00



## Ovládacie rozvádzače ELIWELL COLDFACE - kompaktné rozmery, vrátane regulátora

Typ	Popis	Rozsah motorového spúšťača kompresora [A]	DTN obj. kód	Cena bez DPH
RCS3UDLX21700	3xNTC/PTC; 2HP/16/16/8/8A; 2xDI; 230Va; IP 65; BUZZER, skrutkovacie konektory	230		142,00
RCA3UYRX2C700	3xNTC/PTC; 2HP/16/16/8/8A; 2xDI; 230Va; IP 65; BUZZER, s istením, skrutkovacie konektory, 2xNTC snímače v balení	380		170,00
RCH310DTX1900	EWRC 5030 NT 17-20A 400Vac	380		695,00



## Záznamníky teplôt

Typ	Ilustračný obrázok	Popis	DTN obj. kód	Cena bez DPH
Easylog RC-12		Jednoduchý záznamník teplôt		12,-
Cool logger		Sofistikovaný záznamník teplôt		prosím kontaktujte predajcu

## Silikónové ohrevné káble FLEXELEC

Typ	Dĺžka [m]	Výkon [W]	Menovité napätie [V]	DTN obj. kód	Cena bez DPH
CSC2	1,0	40	230	434.29.1012	
CSC2	1,3	52	230	434.29.1013	19,00
CSC2	1,5	60	230	434.29.1015	19,00
CSC2	2,0	80	230	434.29.1020	22,00
CSC2	3,0	120	230	434.29.1030	24,00
CSC2	4,0	160	230	434.29.1040	38,00
CSC2	5,0	200	230	434.29.1050	44,00
CSC2	6,0	240	230	434.29.1060	45,00



## Ohrevné opasky FLEXELEC na kompresory

Typ	Vykurovacia dĺžka [m]	Výkon [W]	Menovité napätie [V]	DTN obj. kód	Cena bez DPH
FCH 10	0,35		230	434.29.2000	20,00
FCH 20	0,40		230	434.29.2001	
FCH 30	0,45		230	434.29.2003	23,00
FCH 40	0,55		230	434.29.2005	24,00
FCH 50	0,65		230	434.29.2010	25,00
FCH 60	0,75		230	434.29.2015	29,00



## Univerzálne ovládače a riadiace prvky klimatizácií

Názov	Typ	Popis	Obj. číslo DTN	Cena v EUR bez DPH
PC doska	U03A	Univerzálny set PC doska + trafo + čidlá + diaľkové ovládanie na klimatizáciu, 5 módov, 3 rýchlosti ventilátora, ovládanie teploty, časovač, sleep, periodické odtápanie, dva senzory	478.99.1100	61,30 €
PC doska	U03C	Univerzálny set PC doska + trafo + čidlá + diaľkové ovládanie na klimatizáciu, 5 módov, 3 rýchlosti ventilátora, ovládanie teploty, časovač, sleep, periodické odtápanie, dva senzory, automatický reštart	478.99.1105	63,80 €
PC doska	U10A	Univerzálny set PC doska + displej + trafo + čidlá + diaľkové ovládanie na klimatizáciu, 5 módov, 3 rýchlosti ventilátora, ovládanie teploty, dva senzory, displej na zobrazovanie stavu	478.99.1110	112,10 €
Univerzálny diaľkový ovládač	KT-518	Univerzálny diaľkový ovládač na klimatizácie, jednoduché naučenie na takmer všetky druhy klimatizačných zariadení	478.99.1005	24,00 €
Univerzálny diaľkový ovládač - kľúčienka	KT-G001	Univerzálny diaľkový ovládač na klimatizácie, jednoduché naučenie na takmer všetky druhy klimatizačných zariadení	478.99.1010	4,90 €



## Termostaty PRODIGY

Typ	Popis	Teplotný rozsah [°C]	Kapilára [m]	DTN obj. kód	Cena bez DPH
A 2000	Fixná sonda	-35 až +35	-	210.67.1000	7,20
F 2000	S kapilárou	-35 až +35	1,5	210.67.1005	7,20



## Časovacie hodiny GRÄSSLIN

Typ	Popis	Max. prúd [A]	Menovité napätie [V]	DTN obj. kód	Cena bez DPH
FM/1	Časový modul	16	230	477.99.1270	19,40
MIL72A/1	Spodný diel		230	477.99.1275	9,20



## Elektroinštalačný materiál a príslušenstvo k elektroinštalácii

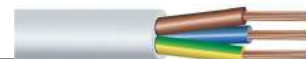

## Silnoprúdové káble s PVC izoláciou do 1kV

Typ	Počet žíl a menovitý prierez jadra	Obvyklá dĺžka v kruhu	Obj. číslo DTN	Cena za 1m v EUR bez DPH
	[mm]	[m]		
CYKY	3 x 1,5	100	211.99.2540	
CYKY	3 x 2,5	100	211.99.2545	1,06,-
CYKY	5 x 1,5	100	211.99.2550	1,08,-
CYKY	5 x 2,5	100	211.99.2555	
CYSY	3x1,5 biely	-	211.99.2560	0,88,-
JYTY	02Ax1	-	211.99.2565	

## Príslušenstvo k elektroinštalácii

Názov	Typ	Rozmer	Počet [ks] v balení	Obj. číslo DTN	Cena v EUR bez DPH	
Viazacia páska čierna/biela	NL1-2-5*370	370mm x 5mm	100	371.00.5000	5,75,-	
Izolačná elektrikárska páska - čierna široká	A5030A	30m x 50mm	50	477.40.1025	2,50,-	
Izolačná elektrikárska páska - biela široká	A5030A	30m x 50mm	50	477.40.1025	2,50,-	
Hliníková páska ALU	30 µm	50m x 50mm	-	371.40.1005	5,60,-	
Hliníková páska ALU	30 µm	50m x 100mm	-	371.40.1010	11,00,-	

## Elektroinštalčné náradie

Názov	Typ	Obj. číslo DTN	Cena v EUR bez DPH	
Multimeter kliešťový	DT-266	504.40.1100	6,80	
Multimeter kliešťový, U <sub>dc</sub> =400mV až 600V, U <sub>ac</sub> =4V až 600V TRMS, I <sub>dc</sub> =40A/400A, I <sub>ac</sub> =40A/400A TRMS, R=400 Ohm až 40 MOhm automatická voľba rozsahu	UT-203	504.40.1105	45,00	
Multimeter kliešťový, U <sub>dc</sub> =400mV až 600V, U <sub>ac</sub> =4V až 600V TRMS, I <sub>dc</sub> =40A/400A, I <sub>ac</sub> =40A/400A TRMS, R=400 Ohm až 40 MOhm Frekvencia 10Hz - 1MHz max, automatická voľba rozsahu	UT-204	504.40.1110	63,30	

## Rozbehové kondenzátory

Typ	Popis	Obj. číslo DTN	Cena v EUR bez DPH	
Rozbehový kondenzátor	330V 88-108uF	530.00.1171	6,80	
Rozbehový kondenzátor	330V 108-130uF	530.00.1175	7,80	
Rozbehový kondenzátor	60-80uF	530.00.1145	2,70	
Rozbehový kondenzátor	80-100uF	530.00.1170	9,80	

# Náradie



## Vákuové čerpadlá

Typ	Dvojstupňové prevedenie	Obj. číslo DTN	Cena v EUR bez DPH	Popis
VALUE VE 115	x	501.40.1005	119,00 €	výkon [lit/min] 51 pracovné vákuum [mikrón] 150
LT-1A	x	501.40.1000	114,00 €	výkon [lit/min] 30 pracovné vákuum [mikrón] 150
VALUE VE 125	x	501.40.1010	156,00 €	výkon [lit/min] 84 pracovné vákuum [mikrón] 150
VALUE VE 215	✓	501.40.1015	234,00 €	výkon [lit/min] 50 pracovné vákuum [mikrón] 15
VALUE VE 225	✓	501.40.1020	266,00 €	výkon [lit/min] 84 pracovné vákuum [mikrón] 15
VALUE VE 245	✓	501.40.1025	329,00 €	výkon [lit/min] 142 pracovné vákuum [mikrón] 15
VALUE VE 280	✓	501.40.1030	495,00 €	výkon [lit/min] 254 pracovné vákuum [mikrón] 15
LT-1A	x	501.40.1000	114,00 €	výkon [lit/min] 30 pracovné vákuum [mikrón] 150



Príslušenstvo VE vákuových čerpadiel:



## Odsávacie jednotky na chladivo

Typ	Chladivo R410A	Obj. číslo DTN	Cena v EUR bez DPH	Popis
BOSCH ECOMAX-E	✓	501.88.1000	838,00 €	odsávanie kvapaliny pre R410A [kg/hod] 58,25 odsávanie plynu pre R410A [kg/hod] 8,18 lokálne odsávanie pre R410A [kg/hod] 229,13
BOSCH MINIMAX-E	✓	501.88.2000	0,00 €	odsávanie kvapaliny pre R410A [kg/hod] 90 odsávanie plynu pre R410A [kg/hod] 9 lokálne odsávanie pre R410A [kg/hod] 354
BOSCH RG5410A-E	✓	501.88.2005	1 540,00 €	odsávanie kvapaliny pre R410A [kg/hod] 111 odsávanie plynu pre R410A [kg/hod] 9,6 lokálne odsávanie pre R410A [kg/hod] 373,2
BOSCH RG6-E	✓	501.88.2020	1 596,00 €	odsávanie kvapaliny pre R410A [kg/hod] 164,4 odsávanie plynu pre R410A [kg/hod] 9,6 lokálne odsávanie pre R410A [kg/hod] 456



Odsávacie jednotky na chladivo je zakázané používať na prečerpávanie čistého chladiva (z fľaše do fľaše) !!!

## Váhy

Typ	Max. hmotnosť [kg]	Presnosť [%]	DTN obj. číslo	Cena bez DPH
BOSCH TIF9030E	100	+0,5	501.88.1100	199,-
WPS 100	100	+0,5	501.40.2010	149,-





## Zváračky

Typ	Kyslíková fľaša [ml/g]	PB fľaša [ml/g]	DTN obj. číslo	Cena bez DPH
TURBO SET 90	930/136	610/350	504.99.1200	164,-
OXI GAS 3	2000	1000	504.99.1000	322,-
OXI GAS 6	6000	4000	504.99.1005	368,-

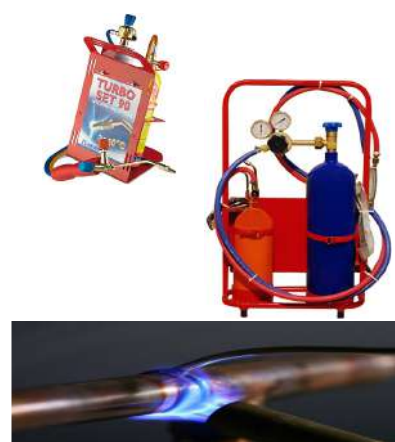

ZVÁRAČKY

## Príslušenstvo k zváračkám

Typ	Pre zváračku	Médium	Obj. číslo DTN	Cena v EUR bez DPH
Preplňovací set	OXI GAS 3/6	kyslík/propán	504.99.1010	60,00
Náhradná náplň	TURBO SET 90	kyslík 930ml/136g	505.65.1070	21,00
Náhradná náplň	TURBO SET 90	propán 610ml/350g	505.65.1075	11,00



## Detekčné náradie

Typ	Kufrík ako príslušenstvo	Chladivo	Citlivosť [g/rok]	DTN obj. číslo	Cena bez DPH
ROBINAIR TIF RX1A	✓	R22 R134a R404A/R507 R407C R410A	7	503.88.1015	355,-
ROBINAIR TIF ZX1A	✓	R22 R134a R404A/R507 R407C R410A	3	503.88.1016	598,-
ROBINAIR TIF 8800INLT	✓	R600a	500 ppm(R600a)	503.88.1017	375,-
ROBINAIR TIF XP-1A	✓	R22 R134a R404A/R507 R407C R410A	3	503.88.1012	430,-
ROBINAIR TIF IR-1A	✓	R22 R134a R404A/R507 R407C R410A	2	503.88.1030	523,-



Detekčný set TECNOSYSTEMI	250ml detekčná látka 50ml aplikačná striekačka 1/4" plniaca hadica 5/16" plniaca hadica UV svetlo + ochranné okuliare	-	11155110	73,00 €
---------------------------	---	---	----------	---------



## Meracie zariadenia teploty infračerveným laserom

Typ	Kufřík ako príslušenstvo	Merací rozptyl	Rozsah teplôt [°C]	DTN obj. číslo	Cena v EUR bez DPH
Infra teplomer AR842A	✓	01:12	-50 - +550	504.40.1075	167,-
Infra teplomer AR350	x	01:12	-50 - +480	504.40.1065	115,-
Infra teplomer AR390	x	01:12	-50 - +390	504.40.1085	62,-



## Meracie zariadenia prietoku vzduchu a teploty

Typ	Kufřík ako príslušenstvo	Rozsah prietoku vzduchu [m/s]	Rozsah teplôt [°C]	DTN obj. číslo	Cena v EUR bez DPH
Anemometer AR836	✓	0,3 - 45	0 - +45	504.40.1090	241,-
Anemometer AR816	x	0,3 - 30	-10 - +45	504.40.1095	89,-

## Rozťahovačky

Typ	Kufřík ako príslušenstvo	Rozsah [mm]	Príslušenstvo v kufříku [ks]	Obj. číslo DTN	Cena v EUR bez DPH
TECNOSYSTEMI hydraulická rozťahovačka	✓	3/8 až 1 1/8	9	11132149	297,00 €
CT-2000	✓	10 až 28	9	505.40.1080	245,00 €



## Rozťahovacie hlavice

K typu	Rozmer [mm]	Kód výrobcu	DTN obj. číslo	Cena bez DPH
CT-2000	10	-	505.40.1165	30,-
	12	-	505.40.1170	30,-
	16	-	505.40.1175	30,-
	22	-	505.40.1190	30,-
	28	-	505.40.1195	30,-
	35	-	505.40.1200	30,-
	42	-	505.40.1205	30,-



## Ohýbačky

Typ	Kufřík ako príslušenstvo	Rozsah [mm/"]	Počet nástavcov v kufříku [ks]	Obj. číslo DTN	Cena v EUR bez DPH
TECNOSYSTEMI	✓	3/8" až 7/8"	7	505.53.1100 11132057	134,00 €
CT-999	✓	10 až 28	9	505.40.1125	168,00 €
BOSCH 370-FH	✓	1/4" až 1/2"	X		64,00 €
CT-369	x	6 až 12	-	505.40.1105	14,00 €



## Meracie zariadenia hlučnosti

Typ	Kufrik ako príslušenstvo	Rozsah [dBA]	DTN obj. číslo	Cena v EUR bez DPH
Hlukomer AR814	✓	30 - 130	504.40.1080	148,-

## Rezačky

Typ	Rozsah [mm]	Obj. číslo DTN	Cena v EUR bez DPH
BOSCH Rezačka mini RATC10001 Titánový nôž !!	4 až 32	505.88.1100	41,70 €
BOSCH Rezačka mini RATC10002 Nickel	4 až 32	505.88.1095	31,80 €
BOSCH Rezačka FB-206 10-66mm	10 až 66		80,00 €
BOSCH Rezačka FA-406 51-104mm	51 až 104		178,00 €
TECNOSYSTEMI Rezačka veľká	5 až 50	505.53.1020 11132183	17,00 €
TECNOSYSTEMI Rezačka malá	3 až 28	505.53.1010 11132066	11,00 €
TECNOSYSTEMI Rezačka mini	3 až 16	505.53.1015 11132067	8,00 €
Rezačka veľká CT-206	14 až 63	505.40.1030	55,00 €
Rezačka veľká CT-107	6 až 42	505.40.1015	22,00 €
Rezačka veľká CT-105	3 až 35	505.40.1005	17,00 €
Rezačka veľká CT-106	4 až 32	505.40.1010	17,00 €
Rezačka veľká CT-127	3 až 16	505.40.1020	7,00 €
TECNOSYSTEMI Rezačka kapilárnych trubiek	0,1 až 3,5	505.53.2000 11132186	7,00 €
Rezačka kapilárnych trubiek CT-215	0,1 až 3,5	505.40.1050	8,00 €

## Príslušenstvo k rezačkám

Typ	Pre rezačku		Obj. číslo DTN	Cena v EUR bez DPH
Náhradné koliesko		CT-127 až CT-206	505.40.1035	1,00 €
Náhradné koliesko	TECNOSYSTEMI	malá rezačka	505.53.1090 11132185	1,90 €
Náhradné koliesko	TECNOSYSTEMI	veľká rezačka	505.53.1095 11132184	2,20 €



REZAČKY



## Pertlovačky

Typ	Kufrik ako príslušenstvo	Rozsah [„/mm]	Príslušenstvo v kufriku [ks]	Obj. číslo DTN	Cena v EUR bez DPH
TECNOSYSTEMI Pertlovačka excentrická s račňou „mostík v palcoch“	✓	3/16" až 3/4"	2	505.53.1305 11132029	138,00 €
BOSCH Pertlovačka excentrická RA801E „mostík v palcoch“	✓	1/4" až 3/4"	2		115,00 €
BOSCH Pertlovačka excentrická RA801E „metrický mostík „	✓	6 až 19	2		120,40 €
Pertlovačka s rozťahovačkou LT-275A	✓	1/4" až 3/4"	10		45,00 €
TECNOSYSTEMI Pertlovačka s rozťahovačkou malá	✓	1/4" až 3/4"	11	11132007	49,00 €
ITE Pertlovačka so zveráčikom FT-525-IT	x	6 až 16	-		38,00 €
Pertlovačka so zveráčikom CT-525	x	6 až 16	-	505.40.1110	31,00 €



PERTLOVAČKY

## Ostatné náradie

Typ	Obj. číslo DTN	Cena v EUR bez DPH	Popis
TECNOSYSTEMI Kliešte na stláčanie potrubia	505.53.1000 11132056	11,00 €	
BOSCH Servisné kliešte „napichovacie“ PT-109	505.88.1025	48,00 €	
BOSCH Servisný magnet SVOM-18	505.88.1000	31,00 €	
Teleskopický magnet CT-60	505.40.1115	9,50 €	
BOSCH Račňový kľúč 127-C	505.88.1235	15,50 €	
Račňový kľúč CT-122	505.40.1075	8,00 €	
BOSCH Račňový kľúč 127-CO	505.88.1135	15,50 €	
TECNOSYSTEMI Sada momentových kľúčov	505.53.1245 11131096	75,00 €	
TECNOSYSTEMI Sada ohybných pružín	505.53.1040 11132076	14,00 €	priemer [mm] 6-10-12-16-18
Ohýb.set na izol.potr.d4,7,10,12 mm, l=4000 mm	9899-850-00	44,00 €	4,7,10,12 mm
TECNOSYSTEMI Kontrolné zrkadlo-veľké	505.53.1030 11132102	10,00 €	priemer [mm] 52
TECNOSYSTEMI Kontrolné zrkadlo-malé	505.53.1025 11132101	9,00 €	priemer [mm] 32
Ohraňovač trubiek s rúčkou	505.40.1090	9,70 €	
Ohraňovač trubiek vonkajší/vnútorňý	505.53.1020	10,50 €	



Typ	Obj. číslo DTN	Cena v EUR bez DPH	Popis
Náradie na vyberanie ventilčekov TLVC-2	506.00.1085	2,80 €	
<b>BOSCH</b> Hrebeň na lamely - plastový RA18403	505.88.1135	14,00 €	
Hrebeň na lamely - plastový CT-351	505.40.1095	4,20 €	
Teplomer napichovací analógový TJ3	504.40.1040	4,80 €	
Teplomer napichovací digitálny WT-1	504.40.1045	8,50 €	teplotný rozsah [C°] -50 až +300
Teplomer napichovací digitálny WT-2	504.40.1050	23,50 €	teplotný rozsah [C°] -50 až +300
Teplomer digitálny, vonkajšia, vnútorná teplota, vlhkomer DT-3	504.40.1020	18,00 €	
Teplomer zabudovaný s ukazovateľom hodín TPM-10B	504.40.1005	7,50 €	teplotný rozsah [C°] -50 až +70
Teplomer digitálny, vonkajšia, vnútorná teplota, čas DS-1	504.40.1015	7,50 €	teplotný rozsah [C°] -50 až +70
Teplomer zabudovaný TPM-900	504.40.1010	14,00 €	teplotný rozsah [C°] -50 až +110
Teplomer zabudovaný TMP-10A	504.40.1000	4,90 €	teplotný rozsah [C°] -50 až +70



MANOMETRE

## Manometre

Typ	Kufřík ako príslušenstvo	Pre chladivá	Príslušenstvo v kufříku [ks]	Obj. číslo DTN	Cena v EUR bez DPH
<b>BOSCH</b> Digitálny manometer RA 43180E150C	✓	19 chladiv	3 x hadica	502.88.1010	454,00 €
<b>BOSCH</b> Digitálny manometer RA 43180E90C	✓	19 chladiv	3 x hadica	502.88.1011	432,00 €
<b>BOSCH</b> Manometer RA 41138E90C	✓	R22 R407C R410A	3 x hadica	502.88.1035	192,00 €
<b>BOSCH</b> Manometer RA 41182E90C	✓	R422, R404A R407C R134a	3 x hadica	502.88.1115	186,00 €
<b>BOSCH</b> Manometer RA 41138E	x	R22 R407C R410A	-	502.88.1036	82,00 €
<b>BOSCH</b> Manometer RA 41178E	x	R22, R404A R407C R134a	-	502.88.1026	82,00 €
<b>BOSCH</b> Manometer RA 41182E	x	R422, R404A R407C R134a	-	502.88.1016	82,00 €
<b>BOSCH</b> Manometer RA 41132E	x	R32, R410A	-	502.88.1017	90,00 €
<b>BOSCH</b> Digitálny manometer nízkotlaký RA 11910-E	x	7	-	502.88.2000	149,00 €
<b>BOSCH</b> Digitálny manometer vysokotlaký RA 11920-E	x	19 chladiv	-	502.88.2005	149,00 €



Typ	Kufrik ako príslušenstvo	Pre chladivá	Príslušenstvo v kufriku [ks]	Obj. číslo DTN	Cena v EUR bez DPH
BOSCH Manometer nízkotlaký RA 41138LP	x	R22 R407C R410A	-	502.88.2010	12,50 €
BOSCH Manometer vysokotlaký RA 41138HP	x	R22 R407C R410A	-	502.88.2015	12,50 €
BOSCH Manometer nízkotlaký RA 41178LP	x	R22, R404A R407C R134a	-	502.88.2030	12,50 €
BOSCH Manometer vysokotlaký RA 41178HP	x	R22, R404A R407C R134a	-	502.88.2035	12,50 €
BOSCH Manometer nízkotlaký RA 41132LP	x	R32, R410A	-		18,50 €
BOSCH Manometer vysokotlaký RA 41132HP	x	R32, R410A	-		18,50 €
BOSCH Manometer digitálny RA VG-1	x	-	-	502.88.7002	207,00 €
BOSCH Regulátor tlaku dusíka 601GN-55 MAX 65bar	x	-	-		221,60 €



Príslušenstvo k manometrom

Typ	Pre chladivá	Obj. číslo DTN	Cena v EUR bez DPH	Popis
TECNOSYSTEMI Set hadíc	R22, R404A R407C, R134a	502.53.3000 11132021	33,00 €	dĺžka hadice [mm] 1500
TECNOSYSTEMI Set hadíc	R22, R404A R407C, R134a	502.53.3005 11132022	62,00 €	dĺžka hadice [mm] 3000
TECNOSYSTEMI Set hadíc	R410A	502.53.3006 11132020	40,00 €	dĺžka hadice [mm] 1500
TECNOSYSTEMI Set hadíc	R410A	502.53.3010 11132124	66,00 €	dĺžka hadice [mm] 3000
BOSCH Uzatvárací ventil na hadicu modrý RA BV1/4B BOSCH	R22, R404A R407C, R134a	502.88.3317	15,50 €	
BOSCH Uzatvárací ventil na hadicu červený RA BV1/4R BOSCH	R22, R404A R407C, R134a	502.88.3316	15,50 €	
BOSCH Uzatvárací ventil na hadicu žltý RABV1/4Y	R22, R404A R407C, R134a	502.88.3318	15,50 €	
TECNOSYSTEMI Ventil uzatvárací 5/16"	R410A		22,00 €	
BOSCH Ventil na autoklímu modrý RA 19885	R134a	502.88.3321	62,50 €	
BOSCH Ventil na autoklímu červený RA 19886	R134a	502.88.3326	62,50 €	
HANSEN Ventil na vyberanie ventilčeka TLVC-138	R410A	505.40.1135	109,40 €	
HANSEN Ventil na vyberanie ventilčeka TLVC-135	R410A	505.40.1130	109,40 €	



Typ	Pre chladivá	Obj. číslo DTN	Cena v EUR bez DPH	Popis
Ventil pre izobutánové fľaše LT-340	R600a	505.40.1140	3,80 €	
Ventil pre izobutánové fľaše LT-341	R600a	505.40.1141	18,50 €	
Teflónové tesnenie do hadíc P-509-T	-	503.46.8010 9880871	7,30 €	
Gumené tesnenie do hadíc BOSCH 40083	-	40083	3,90 €	
Gumové tesnenie do hadíc P-509	-	503.46.8015 9880872	3,90 €	
BOSCH Rýchlospojka na hadicu Priama 16-C	R22, R404A R407C, R134a	502.88.3330	21,00 €	
BOSCH Rýchlospojka na hadicu Rohová 17-C	R22, R404A R407C, R134a	502.88.3335	25,00 €	
BOSCH Rýchlospojka na hadicu Priama 26-C	R410A	502.88.3340	22,00 €	
BOSCH Rýchlospojka na hadicu Rohová 27-C	R410A	502.88.3345	27,00 €	
BOSCH Redukcia na R410A RARG180-5-4	R410A	502.88.3350	6,50 €	



PRÍSLUŠENSTVO K MANOMETROM





# Stavebné prvky chladiacich miestností

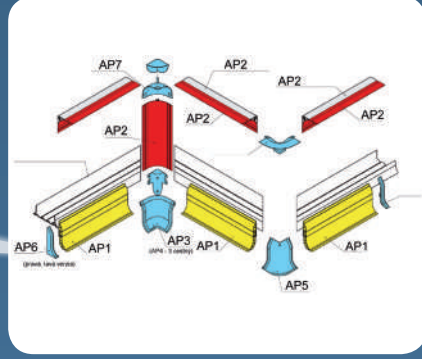

CHLADIACIE MIESTNOSTI

**Refra<sup>®</sup>**



**Chladiarenské dvere Refra**

**Závesné dvere - krídlové - typ BC - rozmer znamená čistý dverný prechod**

Model	Typ	Teplotný rozsah [°C]	rozmer otvoru š/v [cm]	Obj. číslo DTN		Cena v EUR bez DPH	Popis
				L	P		
Závesné dvere - krídlové - typ BC - rozmer znamená čistý dverný prechod	DP - Chladiarenské	0°C	85 x 190	621.51.1010	621.51.1015	799 €	1. PVC PREDNÝ RÁM 2. HLINÍKOVÁ OBRUBA 3. LAKOVANÁ OCEĽ 4. BEZPEČNOSTNÁ KĽUČKA ZVNÚTRA 5. VONKAJŠIA KĽUČKA 6. GUMENNÉ TESNENIE 7. IZOLOVANÉ TELESO DVIER 8. PÁNTY
			100 x 200	621.51.1020	621.51.1025	823 €	
			100 x 220	621.51.1030	621.51.1035	847 €	
			120 x 220	621.51.1040	621.51.1045	871 €	
			130 x 230	621.51.1050	621.51.1055	895 €	
	DM - mraziarenské	-25°C	85 x 190	621.51.1070	621.51.1075	853 €	
			100 x 200	621.51.1080	621.51.1085	961 €	
			100 x 220	621.51.1090	621.51.1095	1 033 €	
			120 x 220	621.51.1100	621.51.1105	1 105 €	
			130 x 230	621.51.1110	621.51.1115	1 177 €	

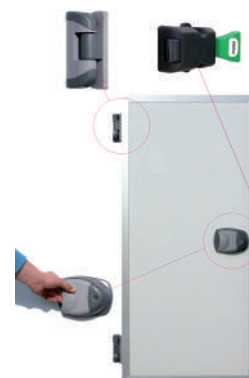

Dvere s označením DP sú bez ohrevu  
 Dvere s označením DM sú s výhrevom 230V/50Hz  
 Dvere s neštandardným rozmerom sú na objednávku  
 a majú cenu najbližších väčších

CHLADIARENSKÉ DVERE REFRA

Na objednávku k dispozícii aj dvere posuvné, dvojkřídlové, s automatizáciou, s prechodom na koľajnicu a podobne.



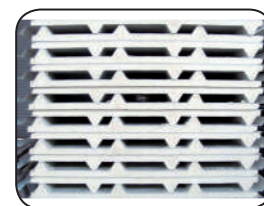

### Polyuretánové Izolačné panely stenové

Farba RAL9002, Priznaný spoj, hrúbka plechu 0,5mm

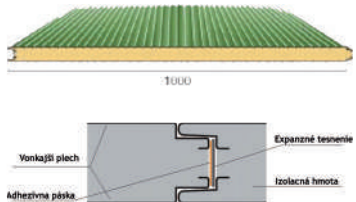
Model	Obj. číslo DTN	hrúbka panela [mm]	Cena v EUR bez DPH	Ilustrácia
PGB PD2,PR2,PDR,PDD	601.41.1005	25	,	
PGB PD2,PR2,PDR,PDD	601.41.1010	30	,	
PGB PD2,PR2,PDR,PDD	601.41.1015	40	,	
PGB PD2,PR2,PDR,PDD	601.41.1020	50	,	
PGB PD2,PR2,PDR,PDD	601.41.1025	60	,	
PGB PD2,PR2,PDR,PDD	601.41.1030	80	,	
PGB PD2,PR2,PDR,PDD	601.41.1035	100	,	
PGB PD2,PR2,PDR,PDD	601.41.1040	120	,	
PGB PD2,PR2,PDR,PDD	601.41.1045	150	,	

### Polyuretánové Izolačné panely strešné

Farba RAL9002, Priznaný spoj, hrúbka plechu 0,5mm

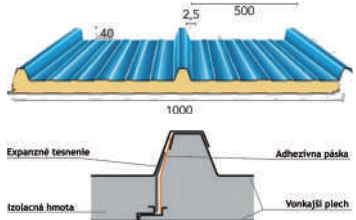
Model	Obj. číslo DTN	hrúbka panela [mm]	Cena v EUR bez DPH	Ilustrácia
PGB TR3,TD3	601.41.1050	30	,	
PGB TR3,TD3	601.41.1055	40	,	
PGB TR3,TD3	601.41.1060	50	,	
PGB TR3,TD3	601.41.1065	60	,	
PGB TR3,TD3	601.41.1070	80	,	
PGB TR3,TD3	601.41.1075	100	,	
PGB TR3,TD3	601.41.1080	120	,	
PGB TR3,TD3	601.41.1085	150	,	

### Sanitárne lišty pre stavby z PUR panelov

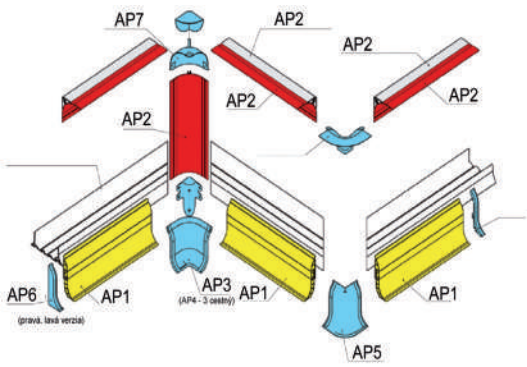
Model	Obj. číslo DTN	označenie lišty	Cena v EUR bez DPH	Ilustrácia
podlahová horizontálna lišta / dĺžka 4m /	602.70.1001	AP 1	6,50 €	
stenová vertikálna/stropná lišta / dĺžka 4m /	602.70.1002	AP 2	6,00 €	
dvojcestný roh podlahový	602.70.1003	AP 3	2,50 €	
trojcestný roh podlahový	602.70.1004	AP 4	3,50 €	
dvojcestný roh podlahový /vonkajší/	602.70.1005	AP 5	2,50 €	
záslepka pre podlahovú lištu - ľavá	602.70.1006	AP 6L	1,50 €	
záslepka pre podlahovú lištu - pravá	602.70.1007	AP 6P	1,50 €	
trojcestný roh pre vertikálne lišty	602.70.1008	AP 7	3,00 €	
pretlaková klapka do hrúbky panelu od 0 - 130 mm /priemer d=80mm/	623.70.1000	-	56,00 €	

\*Panely „stenové“ o hrúbke 60 a 100 mm v dĺžkach 13200 mm sú bežne skladom, o presnej dostupnosti sa informujte na ktorejkoľvek pobočke fi. DTN, s.r.o.

\*Lišty v dĺžkach 4000 mm s uvedenými cenami sú bežne skladom

\*V prípade potreby nacenenia strešných panelov alebo stenových panelov, kde nie je uvedená cena v cenníku, prosím kontaktujte našich obchodných zástupcov na ktorejkoľvek pobočke fi. DTN, s.r.o.

## Príslušenstvo k chladiarenským dverám

Typ	Popis	DTN obj. kód	Cena bez DPH
LT-1132	Pánty otočných dvier	623.40.1010	32,-
LT-1336	Pánty otočných dvier	623.40.1025	8,-
LT-1188/1178	Kľučka k chladiarenským dverám	623.40.1020	62,-



## Krycie elementy oceľové, cena za 1 m

Materiál	Typ profilu	Typ	Rozmery x/y/z [mm]	Dĺžka elementu [mm] / MJ	DTN obj. kód	Cena bez DPH
Oceľ RAL 9002 - lakovaná	„U“ profil	PU 40mm	40/43/40	4 000	602.00.1010	4,50
		PU 60mm	40/63/40	4 000	602.00.1011	5,-
		PU 80mm	40/83/40	4 000	602.00.1012	5,50
		PU 100mm	50/103/50	4 000	602.00.1013	7,-
		PU 120mm	50/123/50	4 000	602.00.1014	7,50
		PU 150mm	50/153/50	4 000	602.00.1015	8,-
	„L“ profil	PU 40mm	40/60/ -	4 000	602.00.1001	3,50
		PU 60mm	50/80/ -	4 000	602.00.1002	4,-
		PU 80mm	50/100/ -	4 000	602.00.1003	5,-
		PU 100mm	70/70/ -	4 000	602.00.1004	4,50
		PU 120mm	80/80/ -	4 000	602.00.1005	5,-
		PU 150mm	100/100/ -	4 000	602.00.1006	6,-
		PU 100mm	30/130/ -	4 000	602.00.1007	5,-
		Inox (nerezová oceľ)	„U“ profil	PU 40mm	40/43/40	2 000
PU 60mm	40/63/40			2 000	602.00.1021	13,-
PU 80mm	40/83/40			2 000	602.00.1022	14,50
PU 100mm	50/103/50			2 000	602.00.1023	18,-
PU 120mm	50/123/50			2 000	602.00.1024	19,-
PU 150mm	50/153/50			2 000	602.00.1025	21,50
„L“ profil	PU 40mm		40/60/ -	2 000	602.00.1026	9,-
	PU 60mm		50/80/ -	2 000	602.00.1027	11,50
	PU 80mm		50/100/ -	2 000	602.00.1028	13,-
	PU 100mm		70/70/ -	2 000	602.00.1029	12,50
	PU 120mm		80/80/ -	2 000	602.00.1030	14,-
	PU 150mm		100/100/ -	2 000	602.00.1031	17,-
	PU 100mm		30/130/ -	2 000	602.00.1032	14,-

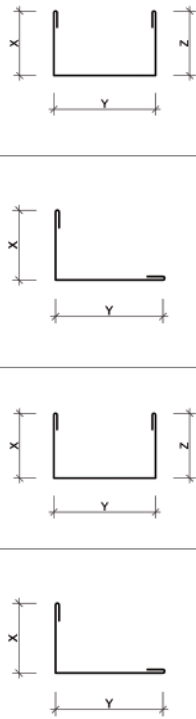





## Nylonové kotviace elementy

Typ	Obj. číslo DTN	Rozmer	Cena v EUR bez DPH	Ilustrácia
Nylonová závitová tyč DIN 975	603.10.1000	M8	8,80 €	
	603.10.1005	M10	11,00 €	
T skrutka s hex (inbus) hlavou + záslepka	603.10.1010	M10	6,60 €	
Matica s rozšíreným ukončením	603.10.1015	M8	0,33 €	
	603.10.1020	M10	0,40 €	
Matica DIN 555 - 534	603.10.1021	M8	0,33 €	
	603.10.1025	M10	0,40 €	
Podložky DIN 125	603.10.1030	M8	0,11 €	
	603.10.1035	M10	0,13 €	
Podložky široké nosné - 45 mm	603.10.1040	M8	1,76 €	

NYLONOVÉ KOTVIACE ELEMENTY

Nylonové kotviace elementy sa používajú na upevňovanie chladiarenských zariadení (výparníky, stropné panely, chladiarenské dvere) všade tam, kde je potrebné zabrániť prestupu tepla. Materiál kotviacich elementov je Nylon 6,6. Jedná sa o priemyselne najtvrdší a najsilnejší nylon. Maximálne povolené zataženie závitů M8 je 50 kg, M10 80 kg, v zvislom smere.

## Pretlaková klapka Elebar BT

Typ	Obj. číslo DTN	Prietok [l/min]	Cena v EUR bez DPH	Popis
 Pretlaková klapka Elebar BT Max. hrúbka steny 130 mm.	603.70.1000	623	56,00 €	Pretlaková klapka s vyhrievaním 220V/50Hz zabraňuje podtlakom najmä v mraziacich boxoch. Pre výpočet počtu klapiek slúži vzorec: $Q = K \times V \times \Delta t$  Q = potrebný prietok vzduchu K = konštanta 3,66 V = objem boxu v m <sup>3</sup> Δt = ochladenie v boxe v °C za 1 min
 Pretlaková klapka MAXI Elebar BT Max. hrúbka steny 250 mm.	603.70.1005	4 300	215,00 €	

NYLONOVÉ KOTVIACE ELEMENTY

# Medené potrubie, izolácie, montážny materiál

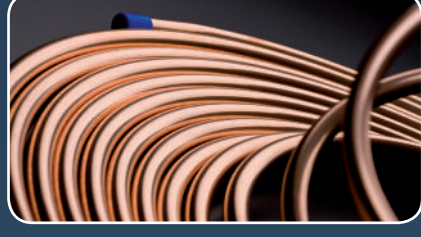



## Chladiarenské medené potrubia - čistené

Norma DIN EN 12735-1 (obsah 99,93% Cu)

Mäkké potrubie vo zvitkoch F 22 - R220				
Priemer [mm]	Bežná dĺžka [m]	Hmotnosť [kg/m]	Cena za 1m v EUR bez DPH	DTN obj. kód
6 x 1	50	0,14	1,69	321.13.1000
8 x 1	50	0,20	2,30	321.13.1010
10 x 1	50	0,25	2,98	321.13.1020
12 x 1	50	0,31	3,62	321.13.1030
15 x 1	50	0,39	4,59	321.13.1040
16 x 1	50	0,42	4,91	321.13.1050
18 x 1	25	0,48	5,57	321.13.1060
22 x 1	25	0,59	6,88	321.13.1070

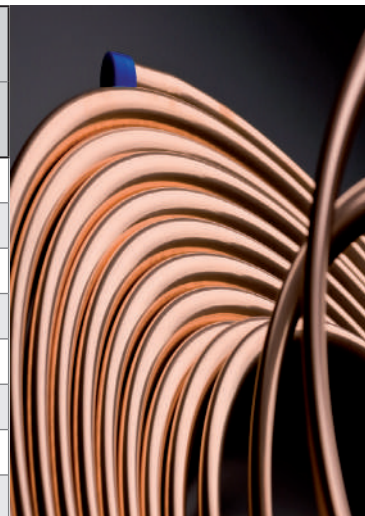

Tvrde potrubie v tyčiach F 36 - R290				
Priemer [mm]	Bežná dĺžka [m]	Hmotnosť [kg/m]	Cena za 1m v EUR bez DPH	DTN obj. kód
10 x 1	5	0,25	2,98	321.13.1110
12 x 1	5	0,31	3,58	321.13.1115
15 x 1	5	0,39	4,55	321.13.1120
16 x 1	5	0,42	4,87	321.13.1125
18 x 1	5	0,48	5,49	321.13.1130
22 x 1	5	0,59	6,76	321.13.1135
28 x 1	5	0,75	8,69	321.13.1140
28 x 1,5	5	1,11	12,85	321.13.1145
35 x 1,5	5	1,40	16,09	321.13.1150
42 x 1,5	5	1,70	19,56	321.13.1155
54 x 2	5	2,91	34,07	321.13.1160
64 x 2	5	3,47	40,69	321.13.1165
76 x 2	5	4,14	50,36	321.13.1170
89 x 2	5	4,86	59,61	321.13.1175
108 x 2,5	5	7,37	90,68	321.13.1180



Polotvrde potrubie v tyčiach F 29 - R250				
16 x 1	5	0,42	2,39	321.13.1210
18 x 1	5	0,48	2,10	321.13.1215





## Chladiarenské medené potrubia - čistené

Norma DIN EN 12735-1 (obsah 99,93% Cu)





Izolované medené potrubie vo zvitkoch (palcové)				
Rozmer [in/mm]	Zvitok [m]	Hmotnosť zvitku vrátane izolácie 9 mm [kg]	Cena za 1m v EUR bez DPH	DTN obj. kód
1/4" x 0,8 6,35 x 0,8	25	3,60	1,65	322.35.1000
3/8" x 0,8 9,52 x 0,8	25	5,50	2,57	322.35.1005
1/2" x 0,8 12,7 x 0,8	25	7,25	3,47	322.35.1010
5/8" x 1 15,88 x 1	25	10,90	5,06	322.35.1015
3/4" x 1 19,05 x 1	25	13,20	6,30	322.35.1020
7/8" x 1 22,22 x 1	25	15,10	7,86	322.35.1025
Izolované medené potrubie párové vo zvitkoch (palcové)				
1/4"+3/8" x 0,8 6,35+9,52 x 0,8	25		4,42	322.35.1100
1/4"+1/2" x 0,8 6,35+12,07 x 0,8	25		5,26	322.35.1105



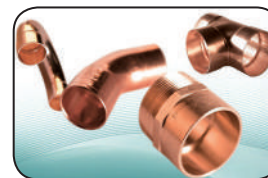



**SANHA®**

Medené tvarovky SANHA



 5001A OBLÚK 90° A/I				 5002A OBLÚK 90° I/I				 5040 OBLÚK 45° A/I				 5041 OBLÚK 45° I/I			
Rozmer [mm]	DTN obj. kód	Balenie [ks]	Cena bez DPH	Rozmer [mm]	DTN obj. kód	Balenie [ks]	Cena bez DPH	Rozmer [mm]	DTN obj. kód	Balenie [ks]	Cena bez DPH	Rozmer [mm]	DTN obj. kód	Balenie [ks]	Cena bez DPH
6	331.50.1000	10	2,94	6	331.50.1100	10	2,34	8	331.50.1200	10	3,36	6	331.50.1300	10	3,80
8	331.50.1005	10	2,93	8	331.50.1105	10	2,53	10	331.50.1205	10	3,33	8	331.50.1305	10	2,65
10	331.50.1010	10	2,13	10	331.50.1110	10	0,99	12	331.50.1210	10	2,82	10	331.50.1310	10	2,51
12	331.50.1015	10	0,78	12	331.50.1115	10	0,43	15	331.50.1215	10	0,36	12	331.50.1315	10	1,57
15	331.50.1020	10	0,43	15	331.50.1120	10	0,46	16	331.50.1220	10	1,04	15	331.50.1320	10	0,46
16	331.50.1025	10	0,72	16	331.50.1125	10	0,72	18	331.50.1225	10	1,24	16	331.50.1325	10	0,81
18	331.50.1030	10	1,01	18	331.50.1130	10	0,64	22	331.50.1230	10	1,19	18	331.50.1330	10	1,10
22	331.50.1035	10	1,19	22	331.50.1135	10	1,00	28	331.50.1235	10	2,34	22	331.50.1335	10	1,23
28	331.50.1040	10	3,35	28	331.50.1140	10	1,58	35	331.50.1240	10	8,70	28	331.50.1340	10	2,23
35	331.50.1045	10	10,12	35	331.50.1145	10	5,40	42	331.50.1245	-	15,27	35	331.50.1345	10	7,91
42	331.50.1050	-	14,60	42	331.50.1150	-	7,55	54	331.50.1250	-	25,23	42	331.50.1350	-	13,98
54	331.50.1055	-	28,12	54	331.50.1155	-	21,55	64	331.50.1255	-	84,07	54	331.50.1355	-	25,23
64	331.50.1060	-	89,67	64	331.50.1160	-	74,53	76	331.50.1260	-	106,24	64	331.50.1360	-	90,49
76	331.50.1065	-	136,89	76	331.50.1165	-	130,50	89	331.50.1265	-	124,39	76	331.50.1365	-	106,32
89	331.50.1070	-	205,48	89	331.50.1170	-	196,98					89	331.50.1370	-	126,59

 5060 OBLÚK 180° I/I				 5090 KOLENO 90° I/I				 5092 KOLENO 90° A/I				 5130 T - TVAROVKA			
Rozmer [mm]	DTN obj. kód	Balenie [ks]	Cena bez DPH	Rozmer [mm]	DTN obj. kód	Balenie [ks]	Cena bez DPH	Rozmer [mm]	DTN obj. kód	Balenie [ks]	Cena bez DPH	Rozmer [mm]	DTN obj. kód	Balenie [ks]	Cena bez DPH
10	331.50.1400	10	3,94	10	331.50.1700	10	1,31	10	331.50.1900	10	2,07	10	331.50.2010	10	1,86
12	331.50.1405	10	4,35	12	331.50.1705	10	0,46	12	331.50.1905	10	1,01	12	331.50.2015	10	1,00
15	331.50.1410	10	6,16	15	331.50.1710	10	0,37	15	331.50.1910	10	0,51	15	331.50.2020	10	0,59
16	331.50.1415	10	6,33	16	331.50.1715	10	0,46	16	331.50.1915	10	0,71	16	331.50.2025	10	0,90
18	331.50.1420	10	9,02	18	331.50.1720	10	0,54	18	331.50.1920	10	1,01	18	331.50.2030	10	1,17
22	331.50.1425	10	10,76	22	331.50.1725	10	0,88	22	331.50.1925	10	1,72	22	331.50.2035	10	2,01
28	331.50.1430	-	15,45	28	331.50.1730	10	1,64	28	331.50.1930	10	2,63	28	331.50.2040	10	3,70
35	331.50.1435	-	33,94	35	331.50.1735	10	6,86	35	331.50.1935	10	10,64	35	331.50.2045	10	10,14
42	331.50.1440	-	52,61	42	331.50.1740	-	10,94	42	331.50.1940	-	14,52	42	331.50.2050	-	19,49
54	331.50.1445	-	88,81	54	331.50.1745	-	21,50	54	331.50.1945	-	29,12	54	331.50.2055	-	32,18
64	331.50.1450	-	274,52	64	331.50.1755	-	98,67					64	331.50.2060	-	133,01
76	331.50.1455	-	239,87	76	331.50.1750	-	108,87					76	331.50.2065	-	165,05
												89	331.50.2070	-	266,53

TVAROVKY

5240 HRDLO REDUKOVANÉ I/I								5243 HRDLO REDUKOVANÉ A/I							
Rozmer [mm]	DTN obj. kód	Balenie [ks]	Cena bez DPH	Rozmer [mm]	DTN obj. kód	Balenie [ks]	Cena bez DPH	Rozmer [mm]	DTN obj. kód	Balenie [ks]	Cena bez DPH	Rozmer [mm]	DTN obj. kód	Balenie [ks]	Cena bez DPH
12-10	331.50.3000	10	1,47	35-18	331.50.3095	-	10,77	12-10	331.50.4000	10	1,23	35-18	331.50.4090	-	7,79
15-10	331.50.3005	10	2,00	35-22	331.50.3100	-	7,53	15-10	331.50.4005	10	1,39	35-22	331.50.4095	-	7,44
15-12	331.50.3010	10	0,82	35-28	331.50.3105	-	9,23	15-12	331.50.4010	10	0,54	35-28	331.50.4100	-	4,99
16-10	331.50.3015	10	1,04	42-22	331.50.3110	-	15,65	16-10	331.50.4015	10	1,24	42-22	331.50.4115	-	13,23
16-12	331.50.3020	10	0,88	42-28	331.50.3115	-	13,23	16-12	331.50.4020	10	0,87	42-28	331.50.4120	-	10,49
16-15	331.50.3025	10	1,27	42-35	331.50.3120	-	10,43	18-12	331.50.4025	10	1,45	42-35	331.50.4125	-	8,86
18-12	331.50.3030	10	1,89	54-28	331.50.3130	-	26,72	18-15	331.50.4030	10	0,47	54-28	331.50.4140	-	22,95
18-15	331.50.3035	10	0,71	54-35	331.50.3135	-	23,06	18-16	331.50.4035	10	0,88	54-35	331.50.4145	-	20,65
18-16	331.50.3040	10	1,24	54-42	331.50.3140	-	19,83	22-12	331.50.4040	10	3,18	54-42	331.50.4150	-	16,78
22-15	331.50.3050	10	1,77	64-35	331.50.3145	-	23,67	22-15	331.50.4045	10	0,88	64-35	331.50.4155	-	39,80
22-16	331.50.3055	10	2,00	64-42	331.50.3150	-	21,68	22-16	331.50.4050	10	1,13	64-42	331.50.4160	-	41,87
22-18	331.50.3060	10	1,18	64-54	331.50.3155	-	28,86	22-18	331.50.4055	10	0,89	64-54	331.50.4165	-	37,39
28-15	331.50.3070	10	3,93	76-54	331.50.3160	-	36,23	28-15	331.50.4065	10	3,33	76-54	331.50.4175	-	50,02
28-16	331.50.3075	10	4,62	76-64	331.50.3165	-	31,57	28-16	331.50.4070	10	4,06	76-64	331.50.4180	-	48,61
28-18	331.50.3080	10	3,87	89-76	331.50.3170	-	64,32	28-18	331.50.4075	10	3,64	89-64	331.50.4185	-	63,99
28-22	331.50.3085	10	1,88					28-22	331.50.4080	10		89-76	331.50.4190	-	61,47

5270 SPOJKA				5301 UZÁVER			
Rozmer [mm]	DTN obj. kód	Balenie [ks]	Cena bez DPH	Rozmer [mm]	DTN obj. kód	Balenie [ks]	Cena bez DPH
6	331.50.5000	10	0,92	10	331.50.5100	10	1,81
8	331.50.5005	10	0,84	12	331.50.5105	10	1,39
10	331.50.5010	10	0,47	15	331.50.5110	10	0,72
12	331.50.5015	10	0,25	16	331.50.5115	10	0,95
15	331.50.5020	10	0,23	18	331.50.5120	10	0,84
16	331.50.5025	10	0,27	22	331.50.5125	10	1,47
18	331.50.5030	10	0,29	28	331.50.5130	10	2,74
22	331.50.5035	10	0,51	35	331.50.5135	10	7,32
28	331.50.5040	10	1,18	42	331.50.5140	-	12,37
35	331.50.5045	10	2,81	54	331.50.5145	-	18,14
42	331.50.5050	-	5,13	64	331.50.5150	-	46,73
54	331.50.5055	-	9,17	76	331.50.5155	-	62,40
64	331.50.5060	-	26,11				
76	331.50.5065	-	33,79				
89	331.50.5070	-	35,37				

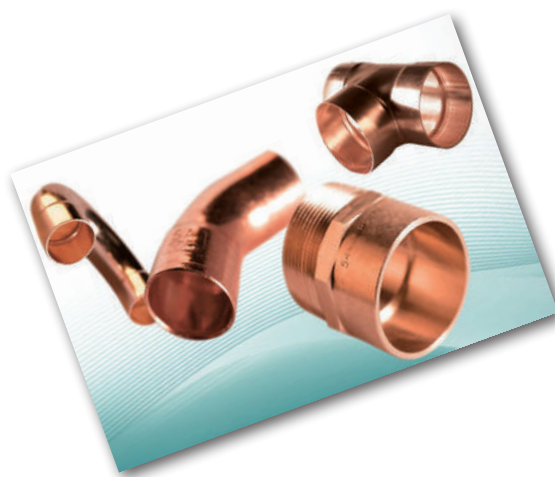

### Spájky

Typ	Zloženie	DTN obj. kód	Cena bez DPH
L-Ag 2P - 1 kg	Ag 2%, Cu 91,5%, P 6,5%	341.28.1005	55,50
L-Ag 5P - 1 kg	Ag 5%, Cu 89%, P 6%	341.28.1010	95,60
L-Ag 15P - 1 kg	Ag 15%, Cu 80%, P 5%	341.28.1015	229,50
L-Ag 30 Sn - 1 kg	Ag 30%, Cu 36%, Zn 32%, Sn 2%	341.28.1030	299,20
L-Ag 30 Sn - 1 ks	Ag 30%, Cu 36%, Zn 32%, Sn 2%	341.28.1030	8,-
L-Ag 40 Sn - 1 kg	Ag 40%, Cu 30%, Zn 28%, Sn 2%	341.28.1035	386,20
L-Ag 40 Sn - 1 ks	Ag 40%, Cu 30%, Zn 28%, Sn 2%	341.28.1035	9,75
L-Cu P6 - 1 kg	Cu 94%, P 6%	341.28.1000	23,75

### Tavidlo

Typ	Objem	DTN obj. kód	Cena bez DPH
Flux - 4	114 g	342.40.1005	3,17



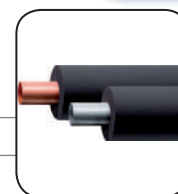

### Izolačné potrubia ST

Dĺžka potrubí 2 metre

Vnútorý rozmer [mm]	Hrúbka izolácie 6 mm			Hrúbka izolácie 9 mm			Hrúbka izolácie 13 mm		
	Počet [m] v balení	Obj. číslo DTN	Cena za 1m v EUR bez DPH	Počet [m] v balení	Obj. číslo DTN	Cena za 1m v EUR bez DPH	Počet [m] v balení	Obj. číslo DTN	Cena za 1m v EUR bez DPH
6	600	361.37.1000	0,65	360	361.37.1100	0,73	240	361.37.1200	0,97
8	500	361.37.1005	0,70	340	361.37.1105	0,75	210	361.37.1205	1,08
10	430	361.37.1010	0,71	320	361.37.1110	0,80	190	361.37.1210	1,17
12	350	361.37.1015	0,75	280	361.37.1115	0,84	172	361.37.1215	1,21
15	300	361.37.1020	0,80	240	361.37.1120	0,88	154	361.37.1220	1,34
18	280	361.37.1025	0,84	190	361.37.1125	0,89	130	361.37.1225	1,44
22	216	361.37.1030	0,89	156	361.37.1130	1,08	110	361.37.1230	1,55
28	150	361.37.1040	1,00	124	361.37.1135	1,17	86	361.37.1235	1,65
35	120	361.37.1045	1,13	92	361.37.1140	1,30	76	361.37.1240	2,01
42				70	361.37.1145	1,47	56	361.37.1245	2,28
54				60	361.37.1150	2,01	46	361.37.1250	3,31
64				54	361.37.1155	2,81	40	361.37.1255	3,75
76				54	361.37.1160	3,37	34	361.37.1260	4,58
89				36	361.37.1170	4,09	30	361.37.1270	5,40
108				28	361.37.1175	6,43	28	361.37.1280	7,73

Vnútorý rozmer [mm]	Hrúbka steny 19 mm			Hrúbka steny 25 mm			Hrúbka steny 32 mm		
	Počet [m] v balení	Obj. číslo DTN	Cena za 1m v EUR bez DPH	Počet [m] v balení	Obj. číslo DTN	Cena za 1m v EUR bez DPH	Počet [m] v balení	Obj. číslo DTN	Cena za 1m v EUR bez DPH
10	106	361.37.1300	1,97	72		3,52			
12	100	361.37.1305	2,01	60		3,54	36		5,83
15	86	361.37.1310	2,42	60		3,62	32		6,08
18	78	361.37.1315	2,55	50	361.37.1400	3,72	32	361.37.1500	6,33
22	74	361.37.1320	2,89	42	361.37.1405	4,13	32	361.37.1505	6,69
28	58	361.37.1325	3,46	40	361.37.1410	4,37	24	361.37.1510	7,01
35	48	361.37.1330	3,98	32	361.37.1415	4,79	24	361.37.1515	7,13
42	40	361.37.1335	4,49	24	361.37.1420	5,99	22	361.37.1520	8,60
54	30	361.37.1340	6,17	22	361.37.1425	7,91	18	361.37.1525	10,75
64	28	361.37.1345	7,35	18	361.37.1430	9,16	16	361.37.1530	12,12
76	28	361.37.1350	8,47	18	361.37.1435	10,24	12	361.37.1535	13,83
89	22	361.37.1360	9,42	14	361.37.1440	11,29	10	361.37.1545	15,29
108	20	361.37.1365	12,99	10	361.37.1445	15,47	8	361.37.1550	21,13

Faktor difúzneho odporu  $\geq \mu$  10000  
 Tepelná vodivosť I 0°C = 0,034 W / (m•K)  
 Stupeň horľavosti ( STN ) B

## Izolačné potrubia vo zvitkoch, plošné izolácie, príslušenstvo

### Izolačné potrubia vo zvitkoch



Vnútorň rozmer [mm]	Hrúbka steny 6 mm		
	Počet [m] v balení	Obj. číslo DTN	Cena za balenie v EUR bez DPH
6	50	362.37.1000	32,58
8	48	362.37.1005	33,44
10	46	362.37.1010	32,56
12	40	362.37.1015	29,21
15	38	362.37.1020	30,31
18	30	362.37.1025	25,28
22	23	362.37.1030	20,42
28	20	362.37.1035	20,00

### Izolačné potrubia vo zvitkoch



Vnútorň rozmer [mm]	Hrúbka steny 9 mm		
	Počet [m] v balení	Obj. číslo DTN	Cena za balenie v EUR bez DPH
6	40	362.37.1100	29,21
8	37	362.37.1105	27,85
10	34	362.37.1110	27,12
12	31	362.37.1115	26,12
15	27	362.37.1120	23,66
18	23	362.37.1125	20,42
22	19	362.37.1130	20,49
28	14	362.37.1135	16,36

### Izolačné potrubia vo zvitkoch



Vnútorň rozmer [mm]	Hrúbka steny 13 mm		
	Počet [m] v balení	Obj. číslo DTN	Cena za balenie v EUR bez DPH
6	26	362.37.1200	25,12
8	26	362.37.1205	28,04
10	23	362.37.1210	26,88
12	18	362.37.1215	21,84
15	17	362.37.1220	22,73
18	15	362.37.1225	21,57
22	14	362.37.1230	21,71
28	10	362.37.1235	16,52

### Kaučukové izolácie MT/EPDM - solar



Vnútorň rozmer [mm]	Hrúbka steny 13 mm		
	Počet [m] v balení	Obj. číslo DTN	Cena za balenie v EUR bez DPH
6	26	362.37.1200	25,12
8	26	362.37.1205	28,04

### Plošné izolácie - role



Hrúbka steny [mm]	Šírka zvitku 1 m		
	m <sup>2</sup> / krabica	Obj. číslo DTN	Cena za balenie v EUR bez DPH
6	30	364.37.1000	7,00
10	20	364.37.1005	10,19
13	14	364.37.1010	11,88
19	10	364.37.1015	18,33
25	8	364.37.1020	22,55
32	6	364.37.1025	28,38

### Plošné izolácie samolepiace s hliníkovou fóliou



Hrúbka steny [mm]	Šírka zvitku 1,5 m		
	m <sup>2</sup> / krabica	Obj. číslo DTN	Cena za balenie v EUR bez DPH
8	14	361.37.5000	15,92
10	10	361.37.5002	17,50
12	8	361.37.5005	19,92
15	7	361.37.5010	24,13
20	6	361.37.5015	25,67

### Izolačné pásy



Rozmer	ks / krabica	Obj. číslo DTN	Cena za ks v EUR bez DPH
3 mm x 50 mm x 15 m	12	371.37.1000	14,55
3 mm x 50 mm x 9,14 m	1	371.40.1000	4,32

### Príslušenstvo



Typ	ks / krabica	Obj. číslo DTN	Cena za ks v EUR bez DPH
Lepidlo 0,5 l	20	372.37.1005	8,00
Lepidlo 2,6 l	6	372.37.1015	30,00
Čistič kaiflex 1 l	12	372.37.1020	9,14
Kaifiniš - ochr.náter 0,75 l	12	372.37.1025	25,57

### Klimatizačné konzoly

Typ	Nosnosť [kg]	DTN obj. kód	Popis	Cena bez DPH
SGL 100 dĺžka 430 mm	100	431.53.1200 111000071	nástenná konzola s horizontálnou lištou (2xL + kotviaca nástenná lišta) 111000071	15,-
SGL 140 dĺžka 475 mm	140	431.53.1205 111000090	nástenná konzola s horizontálnou lištou (2xL + kotviaca nástenná lišta) 111000090	16,-
LT-2003 / BRA-2003 dĺžka 650 mm	120	431.53.1010 111000131	nástenná konzola s horizontálnou lištou (2xL + kotviaca nástenná lišta)	22,-
SG 160 EVO dĺžka 465 mm	160	431.40.1000	nástenná konzola s horizontálnou lištou (2xL + kotviaca nástenná lišta) 111000811	26,-
TSCM-180 dĺžka 510 mm	180	431.40.1005	nástenná konzola s horizontálnou lištou (2xL + kotviaca nástenná lišta) 111000131	28,-
TSTT-140	140	431.53.1015 111000005	Strešná konzola	58,-
DWG-02	200	431.40.1015	Strešná konzola	40,-



### Antivibračné podložky

Typ	Nosnosť [kg]	DTN obj. kód	Cena bez DPH za ks	Ilustrácia
TEKNO 100	80	477.53.1019 11105040	3,-	<p>TEKNO 100      TEKNO 200      TEKNO 300</p> <p>T3      T2      T1      T5      T4</p>
TEKNO 200	130	477.53.1020 11105041	3,-	
TEKNO 300	200	477.53.1025 11105042	8,-	
S1	40	477.53.1000 111000067	1,-	
S3	60	477.53.1005 111000072	1,50	
T2	150	477.53.1010 111000075	2,-	
T3	350	477.53.1015 111000076	4,-	

### PVC konzoly

Typ	Nosnosť [kg]	DTN obj. kód	Rozmery [mm] D x V x Š	Cena bez DPH za ks
365	140	431.53.1100 11105035	365x100x80	5,-
465	240	431.53.1105 11105036	465x100x80	6,-
EXTREME-8 450	300	431.53.1100 11105062	450x140x95	18,10
EXTREME-8 600	400	431.53.1105 11105064	600x140x95	26,00
EXTREME-8 1000	650	431.53.1105 11105066	1000x140x95	40,00



### ALU pásy

Typ	Rozmer	DTN obj. kód	Cena bez DPH
30 µm	50m x 50mm	371.40.1005	5,-
30 µm	50m x 100mm	371.40.1010	11,-

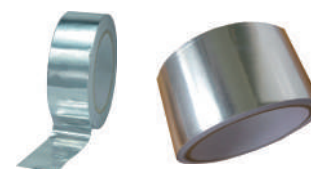

## Prípravné podomietkové krabice na klimatizácie

Typ	Rozmer [mm] D x V x Š	DTN obj. kód	Cena bez DPH
Bez vývodu 11100099	440x55x80	478.53.1075	6,60
S vývodom, malá 11100098	440x55x80	478.53.1070	5,50
S vývodom, veľká 11100095	520x65x85	478.53.1065	7,50



## Čerpadlá kondenzu

Typ	Max. výkon [liter / h ]	Max. výtlak [m]	Samostatný plavák	DTN obj. kód	Popis	Cena bez DPH
ASPEN MINI AQUA	10	10	✓	432.22.1000	Hlučnosť: 21 [dB(A)]	82,-
ASPEN MINI ORANGE	8	14	✓	432.07.1005	Hlučnosť: 35 [dB(A)]	82,-
ASPEN MINI BLANC DELUXE	12	10	X	432.07.1000	Hlučnosť: 21 [dB(A)]	77,-
ASPEN HI FLOW MAX	550	5	X	432.07.1035		72,-
ASPEN MICRO V i4	14,5	10	✓			94,-
ASPEN Standard MK2	6,5	12	X			91,-



**Hadice na kondenz a príslušenstvo**

Typ	Obj. číslo DTN	Cena v EUR bez DPH	Popis	Ilustrácia
Hadica na kondenz	478.53.1030 11126316	54,00 €	Priemer: [mm] 16x18 Dĺžka: [m] 50	
Hadica na kondenz zosilnená	0016TU	19,80 €	Priemer: [mm] 16 Dĺžka: [m] 30	
Spojka na vodu - Y 2 vývody	478.53.1035 11126000	2,20 €	Priemer: [mm] 16x18	
Spojka na vodu - Y 2 vývody	478.53.1040 11126002	3,40 €	Priemer: [mm] 16x18	
Spojka na vodu - Y 3 vývody	478.53.1045 11126003	4,80 €	Priemer: [mm] 16x18	
Mikro sífón	9899-244-01	17,50 €	Rozmer ŠxVxH: [mm] 174x154x58	
Mini sífón	9899-242-01	20,93 €	Rozmer ŠxVxH: [mm] 174x154x58	
Spojka priama na kond.hadicu d16mm	9899-171-01	1,48 €	Priemer: [mm] 16	
Prechod na kondenznú hadicu	9899-143-01	1,80 €	Priemer: [mm] 16	
Prechod na kondenznú hadicu	9899-144-01	2,80 €	Priemer: [mm] 18	
Prechod na kondenznú hadicu	9899-145-01	3,80 €	Priemer: [mm] 20	
Prechod na kondenznú hadicu	9899-146-01	4,80 €	Priemer: [mm] 25	
Prechod na kondenznú hadicu	9899-147-01	5,80 €	Priemer: [mm] 32	
Sífón	478.53.1055 11126321	6,10 €	Priemer: [mm] 16x18x20x25	
Hadica na čerpadlo	478.87.1060 12170014	29,50 €	Priemer: [mm] 6 Dĺžka: [m] 50	
Hadica na čerpadlo Aspen zapletaná	AX51000	15,00 €	Priemer: [mm] 6 Dĺžka: [m] 30	



## Príslušenstvo na kondenz od ASPEN XTRA

Typ	Obj. číslo DTN	Cena v EUR bez DPH/bal.	Ilustrácia
Adaptér 16/21mm	fp2011	€ 9,20	
Adaptér 26/21mm	fp2012	€ 10,10	
Adaptér 32/21mm	fp2013	€ 10,90	
Adaptér 16/20mm	fp2001	€ 9,24	
Adaptér 16/25mm	fp2002	€ 10,10	
Adaptér 16/32mm	fp2003	€ 10,90	
Ohyb 90° 12/16mm, predĺžený	fp2006	€ 9,24	
Adaptér 21/25mm	fp2016	€ 9,24	
Adaptér 21/32mm	fp2017	€ 10,10	
Adaptér 21/40mm	fp2018	€ 10,90	
Adaptér 16mm na 10/6mm	fp2632	€ 7,62	
Navíťateľný prípoj - 6/10 mm	fp2038	€ 18,52	
T spojka - 10 mm	fp2030	€ 12,08	
Náhradná trubka na peristaltické čerpadlo	fp1282	€ 10,74	
Spojka priama - 6 mm	fp2622	€ 10,10	
Koleno - 6 mm	fp2028	€ 10,30	
T spojka - 6 mm	fp2024	€ 10,40	
Spätný ventil - 6 mm	fp2628	€ 15,30	
Redukcia 10mm na 6mm	fp2020	€ 9,14	
Spojka priama - 10 mm	fp2624	€ 11,12	
Koleno - 10 mm	fp2032	€ 11,60	
Adaptér 21mm - 10/6mm	fp2040	€ 6,56	
Spätný ventil - 10 mm	fp2630	€ 16,88	
Poistka 1A	fp2620	€ 8,76	
Zámok na potrubie veľ. 1 - potrubie 6/12 mm	b6186	€ 10,04	
Zámok na potrubie veľ. 2 - potrubie 10/16 mm	b6187	€ 10,26	
Zámok na potrubie veľ. 3 - potrubie 12/22 mm	b6188	€ 9,80	
Zámok na potrubie veľ. 4 - potrubie 19/28 mm	b6189	€ 10,00	
Filter kondenzu 16mm	fp2640	€ 18,86	
Filter kondenzu 6 mm	fp2636	€ 20,14	
Závesný držiak na závitovú tyč 8/10mm veľ. 2 - potrubie 10/16 mm	b6561	€ 18,80	
Závesný držiak na závitovú tyč 8/10mm veľ. 3 - potrubie 12/22 mm	b6562	€ 20,40	
Závesný držiak na závitovú tyč 8/10mm veľ. 4 - potrubie 19/28 mm	b6563	€ 19,40	
Regulátor otáčok ventilátora pre chladenie	AX7001	€ 75,78	
Regulátor otáčok ventilátora pre kúrenie	AX7002	€ 87,56	
Závesný držiak na závitovú tyč 8/10mm veľ. 1 - potrubie 12/16/25 mm	b6361	€ 14,82	
Závesný držiak na závitovú tyč 8/10mm veľ. 2 - potrubie 19/25/28 mm	b6362	€ 16,30	
Závesný držiak na závitovú tyč 8/10mm veľ. 3 - potrubie 16/35/28 mm	b6363	€ 18,04	
Závesný držiak na závitovú tyč 8/10mm veľ. 4 - potrubie 16/42/35 mm	b6364	€ 19,52	
Odpájač 20 A, 4 polia	AX6001	€ 25,60	
Odpájač 32 A, 4 polia	AX6002	€ 25,60	
Odpájač 40 A, 4 polia	AX6003	€ 31,20	
Odpájač 63 A, 4 polia	AX6004	€ 31,20	







Tecnosystemi PVC žľaby a tvarovky

Typ	DTN obj. kód	Kód Tecnosystemi	Rozmery [mm]	Cena bez DPH	
Lišta ECO LINE T-60	433.53.1500	E11120060	2000x52x60	3,58	
Lišta ECO LINE T-72	433.53.1505	E11120072	2000x64x72	4,20	
Lišta ECO LINE T-100	433.53.1510	E11120010	2000x73x98	6,34	
Koncový ohyb do steny ECO LINE TM-60	433.53.1515	E11124160	165x66x55	3,46	
Koncový ohyb do steny ECO LINE TM-72	433.53.1520	E11124172	185x78x68	4,70	
Koncový ohyb do steny ECO LINE TM-100	433.53.1525	E11124110	220x104x77	8,92	
Prechod do steny ECO LINE TA-60	433.53.1530	E11122110	60x56x67	3,78	
Prechod do steny ECO LINE TA-72	433.53.1535	E11122120	62x68x79	4,78	
Prechod do steny ECO LINE TA-100	433.53.1540	E11122130	83x78x104	8,56	
Vonkajší ohyb ECO LINE CA-60	433.53.1545	E11120260	84x55x66	3,22	
Vonkajší ohyb ECO LINE CA-72	433.53.1550	E11120272	95x66x74	4,18	
Vonkajší ohyb ECO LINE CA-100	433.53.1555	E11120210	113x77x104	8,58	
Vnúťorný ohyb ECO LINE CP-60	433.53.1560	E11120160	118x68x78	3,38	
Vnúťorný ohyb ECO LINE CP-72	433.53.1565	E11120172	118x68x78	4,36	
Vnúťorný ohyb ECO LINE CP-100	433.53.1570	E11120100	152x77x104	6,78	
Spojka ECO LINE MG-60	433.53.1575	E11121060	50x55x66	2,90	
Spojka ECO LINE MG-72	433.53.1580	E11121072	50x68x78	3,00	
Spojka ECO LINE MG-100	433.53.1585	E11121100	50x77x104	3,24	
T-kus ECO LINE DT-60	433.53.1590	E11123060	166x121x66	8,74	
T-kus ECO LINE DT-72	433.53.1595	E11123072	200x152x78	16,48	
T-kus ECO LINE DT-100	433.53.1600	E11123100	200x152x104	14,66	
Krytka ECO LINE RM-60	E11122060	56x64	2,62		
Krytka ECO LINE RM-72	433.53.1610	E11122072	68x78		2,86
Krytka ECO LINE RM-100	433.53.1615	E11122100	77x104		3,06
Koncový uzáver ECO LINE TC-60	433.53.1620	E11122170	65x54x64	3,32	
Koncový uzáver ECO LINE TC-72	433.53.1625	E11122180	76x66x76	3,62	
Koncový uzáver ECO LINE TC-100	433.53.1630	E11122190	102x77x105	4,76	
Uzáver k výparníku ECO LINE TS-60	433.53.1635	E11124060	75x55x66	2,84	
Uzáver k výparníku ECO LINE TS-72	433.53.1640	E11124072	90x68x78	3,06	
Uzáver k výparníku ECO LINE TS-100	433.53.1645	E11124100	110x77x104	5,64	
Uzáver k výparníku ECO LINE RC-72/60	433.53.1650	E11123080	80x72	5,46	
Uzáver k výparníku ECO LINE RC-100/72	433.53.1655	E11123105	80x100	5,90	
Úchyt do lišty ECO LINE BLOCK T-60	433.53.1661	E11125016	20x60	0,36	
Úchyt do lišty ECO LINE BLOCK T-72	433.53.1660	E11125017	20x72	0,38	
Úchyt do lišty ECO LINE BLOCK T-100	433.53.1665	E11125018	20x100	0,40	
Ohybná lišta ECO LINE MF-60	433.53.2005	E11124495	520x52x60	4,74	
Ohybná lišta ECO LINE MF-72	433.53.2010	E11124500	520x64x72	5,54	
Ohybná lišta ECO LINE MF-100	433.53.2000	E11124505	520x73x98	6,44	

## PVC lišty a príslušenstvo VECAMCO

Typ	Obj. číslo DTN	Cena v EUR bez DPH	MJ	rozmery: DxŠxV [mm]	Ilustrácia
Lišta euro plus 65x50 mm	9811-001-08	2,44 €	m	2000x50x65	
Lišta euro plus 80x60 mm	9815-001-08	3,34 €	m	2000x60x80	
Lišta euro plus 125x75 mm	9813-001-08	6,07 €	m	2000x75x125	
Lišta clima plus 65x50 mm	9811-001-08	2,60 €	m	2000x50x65	
Lišta clima plus 90x65 mm	9815-001-08	3,67 €	m	2000x65x90	
Lišta pre hadicu na kondenz 35x30 mm	9810-001-08	1,79 €	m	2000x30x35	
Prechod na kondenz 35x30 mm	9810-210-08	0,55 €	ks	30x35	
Spojka na lištu 65x50 mm	9801-102-08	0,95 €	ks	50x65	
Spojka na lištu 80x60 mm	9805-102-08	1,15 €	ks	60x80	
Spojka na lištu 90x65mm	9802-102-08	1,35 €	ks	65x90	
Spojka na lištu 125x75 mm	9803-102-08	1,70 €	ks	75x125	
PVC pružný konektor ku klíme 65x50 mm	9801-103-08	3,20 €	ks	50x65	
PVC pružný konektor ku klíme 90x65 mm	9802-103-08	4,45 €	ks	65x90	
Prechod do steny 65x50 mm	9801-111-08	2,63 €	ks	50x65	
Prechod do steny 80x60 mm	9805-111-08	2,50 €	ks	60x80	
Prechod do steny 90x65 mm	9802-111-08	2,85 €	ks	65x90	
Prechod do steny 125x75 mm	9803-111-08	3,00 €	ks	75x125	
Vnútrotný ohyb 65x50 mm	9801-112-08	1,83 €	ks	50x65	
Vnútrotný ohyb 80x60 mm	9805-112-08	1,88 €	ks	60x80	
Vnútrotný ohyb 90x65 mm	9802-112-08	1,90 €	ks	65x90	
Vnútrotný ohyb 125x75 mm	9803-112-08	1,98 €	ks	75x125	
Ohyb na vonkajší roh 65x50 mm	9801-113-08	1,83 €	ks	50x65	
Ohyb na vonkajší roh 80x60 mm	9805-113-08	2,00 €	ks	60x80	
Ohyb na vonkajší roh 90x65 mm	9802-113-08	2,50 €	ks	65x90	
Ohyb na vonkajší roh 125x75 mm	9803-113-08	1,98 €	ks	75x125	
Koncovný uzáver 65x50 mm	9801-114-08	2,75 €	ks	50x65	
Koncovný uzáver 80x60 mm	9805-114-08	2,65 €	ks	60x80	
Koncovný uzáver 90x65 mm	9802-114-08	2,95 €	ks	65x90	
Koncovný uzáver 125x75 mm	9803-114-08	2,85 €	ks	75x125	
Vonkajší ohyb 65x50 mm	9801-115-08	2,75 €	ks	50x65	
Vonkajší ohyb 80x60 mm	9805-115-08	2,80 €	ks	60x80	
Vonkajší ohyb 90x65 mm	9802-115-08	3,18 €	ks	65x90	
Vonkajší ohyb 125x75 mm	9803-115-08	3,08 €	ks	75x125	
Koncový ohyb do steny 65x50 mm	9801-116-08	2,80 €	ks	50x65	
Koncový ohyb do steny 80x60 mm	9805-116-08	2,85 €	ks	60x80	
Koncový ohyb do steny 90x65 mm	9802-116-08	3,30 €	ks	65x90	
Koncový ohyb do steny 125x75 mm	9803-116-08	3,43 €	ks	75x125	

Typ	Obj. číslo DTN	Cena v EUR bez DPH	MJ	rozmery: DxŠxV [mm]	Ilustrácia
T-kus 80x60 mm	9805-200-08	3,47 €	ks	60x80	
T-kus 90x65 mm	9802-200-08	4,20 €	ks	65x90	
T-kus 125x75 mm	9803-200-08	4,77 €	ks	75x125	
Redukcia 80-65 mm	9801-202-08	2,00 €	ks	65x80	
Redukcia 90x65 mm	9802-201-08	2,05 €	ks	65x90	
Redukcia 125-80 mm	9805-201-08	2,05 €	ks	80x125	
Ohybná lišta 65x50 mm	9801-118-08	12,84 €	ks	50x65	
Ohybná lišta 80x60 mm	9805-118-08	10,68 €	ks	60x80	
Kliešte	9899-990 9899-990	155,48 €	ks		

# Chladivá, mazivá, nemrznúce zmesi, čistiace prostriedky



CHLADIVÁ, MAZIVÁ, NEMRZNÚCE ZMESI, ČISTIACE  
PROSTRIEDKY

CHLADIVÁ

CHLADIVÁ

<b>Fyzické parametre chladiva</b>	<b>R134a</b>		
Enviromentálna klasifikácia	HFC		
Molekulárna hmotnosť	102,3	Balenie 13,6 kg.	<b>R134A</b>
Bod varu (1 atm, °C)	-26.05	Balenie 12 kg.	
Kritický tlak (bar)	40.56	GWP: 1430	
Kritická teplota (°C)	101		
Kritická hustota (gr/cm <sup>3</sup> )	0.512	<b>28,-</b>	
Tekutá hustota (21,1°C, gr/cm <sup>3</sup> )	1,22		
Hustota pár (gr/cm <sup>3</sup> )	0.0052		
<b>Fyzické parametre chladiva</b>	<b>R404A</b>		
Enviromentálna klasifikácia	HFC		
Molekulárna hmotnosť	97,6	Balenie 10,9 kg.	<b>R404A</b>
Bod varu (1 atm, °C)	-46.55	Balenie 9 kg.	
Kritický tlak (bar)	37.79	GWP: 3922	
Kritická teplota (°C)	72.5		
Kritická hustota (gr/cm <sup>3</sup> )	0.574	<b>32,-</b>	
Tekutá hustota (21,1°C, gr/cm <sup>3</sup> )	1.063		
Hustota pár (gr/cm <sup>3</sup> )	0.0054		
<b>Fyzické parametre chladiva</b>	<b>R407C</b>		
Enviromentálna klasifikácia	HFC		
Molekulárna hmotnosť	86,2	Balenie 11,3 kg.	<b>R407C</b>
Bod varu (1 atm, °C)	-42	Balenie 11 kg.	
Kritický tlak (bar)	46.33	GWP: 1774	
Kritická teplota (°C)	86,11		
Kritická hustota (gr/cm <sup>3</sup> )	0.512	<b>36,-</b>	
Tekutá hustota (21,1°C, gr/cm <sup>3</sup> )	1.1589		
Hustota pár (gr/cm <sup>3</sup> )	0.00462		
Náhrada:	za R22		
<b>Fyzické parametre chladiva</b>	<b>R410A</b>		
Enviromentálna klasifikácia	HFC		
Molekulárna hmotnosť	72,6	Balenie 11,3 kg.	<b>R410A</b>
Bod varu (1 atm, °C)	-51.66	Balenie 9 kg.	
Kritický tlak (bar)	47.69	GWP: 2088	
Kritická teplota (°C)	70.16		
Kritická hustota (gr/cm <sup>3</sup> )	0.552	<b>36,-</b>	
Tekutá hustota (21,1°C, gr/cm <sup>3</sup> )	1.085		
Hustota pár (gr/cm <sup>3</sup> )	0.00418		
<b>Fyzické parametre chladiva</b>	<b>R417A</b>		
Enviromentálna klasifikácia			
Molekulárna hmotnosť		Balenie 12 kg.	<b>R417A</b>
Bod varu (1 atm, °C)		GWP: 2346	
Kritický tlak (bar)			
Kritická teplota (°C)		<b>32,-</b>	
Kritická hustota (gr/cm <sup>3</sup> )			
Tekutá hustota (21,1°C, gr/cm <sup>3</sup> )			
Hustota pár (gr/cm <sup>3</sup> )			
<b>Fyzické parametre chladiva</b>	<b>R32</b>		
Enviromentálna klasifikácia	HFC		
Molekulárna hmotnosť	52,02	Balenie 3 kg.	<b>R32</b>
Bod varu (1 atm, °C)	-51.65	GWP: 675	
Kritický tlak (bar)	53,8		
Kritická teplota (°C)	78,4	<b>16,-</b>	
Bod skvapalnenia (°C)	-137		
Teplota samovznietenia (°C)	648		
Hustota pár (gr/cm <sup>3</sup> )			
<b>Fyzické parametre chladiva</b>	<b>R449A</b>		
Enviromentálna klasifikácia			
Molekulárna hmotnosť		Balenie 9 kg.	<b>R449A</b>
Bod varu (1 atm, °C)		GWP: 1397	
Kritický tlak (bar)			
Kritická teplota (°C)		<b>35,-</b>	
Kritická hustota (gr/cm <sup>3</sup> )			
Tekutá hustota (21,1°C, gr/cm <sup>3</sup> )			
Hustota pár (gr/cm <sup>3</sup> )			
<b>Fyzické parametre čistiacej kvapaliny</b>			
Enviromentálna klasifikácia			
Molekulárna hmotnosť	116,9	Balenie 5 kg.	<b>Čistiaca kvapalina</b>
Bod varu (1 atm, °C)	32		
Kritický tlak (bar)	44	<b>10,-</b>	
Kritická teplota (°C)	208,3		
Kritická hustota (gr/cm <sup>3</sup> )			
Tekutá hustota (21,1°C, gr/cm <sup>3</sup> )	1.24		
Hustota pár (gr/cm <sup>3</sup> )			

Prenájom vratných fľaš: Plniteľná fľaša je obchodná komodita, ktorá sa fakturuje v hodnote 50,-€ pri prevzatí spolu s chladivom. Po vrátení fľaše sa zákazníkovi dobropišuje plná hodnota fľaše späť.

Chladivo sa predáva výhradne držiteľom osvedčenia o odborných znalostiach a certifikovaným subjektom o odbornej spôsobilosti na nakladanie s F-plynmi.



Mazivá EMKARATE



MAZIVÁ

Typ maziva	Objem [L]	Popis	Počet [ks] v balení	Obj. číslo DTN	Cena v EUR bez DPH
RL 22H	1	-	12	302.60.1000	31,00 €
	5		4	302.60.1005	132,00 €
	20		1	302.60.1010	504,00 €
RL 32H	1	Mazivo certifikované pre kompresory	12	302.60.1015	29,60 €
	5	<b>BITZER</b> I·N·T·E·R·N·A·T·I·O·N·A·L	4	302.60.1020	128,00 €
	20		1	302.60.1025	492,00 €
	200	Kód Bitzer BSE 32	1	302.60.1030	4 628,00 €
RL 32-3MAF	1	Mazivo certifikované pre kompresory	12	302.60.1035	31,00 €
	5	<b>Copeland</b> brand products	4	302.60.1040	134,50 €
	20		1	302.60.1045	504,00 €
RL 46H	1	-	12	302.60.1050	34,00 €
	5		4	302.60.1055	147,00 €
	20		1	302.60.1060	566,00 €
RL 68H	1	Mazivo certifikované pre kompresory	12	302.60.1070	34,00 €
	5	<b>BITZER</b> I·N·T·E·R·N·A·T·I·O·N·A·L	4	302.60.1075	147,00 €
	20		1	302.60.1080	566,00 €
	200	Kód Bitzer BSE 55	1	302.60.1085	5 316,00 €
RL 100H	1	Mazivo pre autoklímy	12	302.60.1090	34,50 €
	5		4	302.60.1095	149,00 €
	20		1	302.60.1100	575,00 €
	200		1	302.60.1105	5 476,00 €
RL 170H	1	Mazivo certifikované pre kompresory	12	302.60.1110	35,00 €
	5	<b>BITZER</b> I·N·T·E·R·N·A·T·I·O·N·A·L	4	302.60.1115	155,00 €
	20		1	302.60.1120	591,50 €
	200	Kód Bitzer BSE 170	1	302.60.1125	5 651,00 €
RL 2000	1	Supermazivo pre autoklímy	12	302.60.1130	26,00 €



Mazivá MANEUROP









Typ maziva	MJ [L]	Popis	Počet [L] v balení	Obj. číslo DTN	Cena za MJ v EUR bez DPH
160 P	1	Minerálny olej, pre R22	2	302.18.1000	25,50 €
160 PZ	1	POE olej pre nové chladivá	2	302.18.1010	77,80 €
175 PZ	1	POE olej pre nové chladivá	2,5		65,50 €
160 SZ	1	POE olej pre nové chladivá	2,5	302.18.1015	63,00 €



Oleje ROBINAIR/REFCO do vákuovačky

Typ oleja	Objem [L]	Popis	Počet [ks] v balení	Obj. číslo DTN	Cena v EUR bez DPH
DV-05 RA13119	0,50	Olej do vákuovačky	1	501.46.8030	11,50 €
DV-06 RA13203	1,00	Olej do vákuovačky	1	501.46.8025	16,00 €

Čistiace prostriedky ALCORE (citrónová vôňa)

Typ	Náplň [ml]	DTN obj. číslo	Cena v EUR bez DPH	
Sprej na čistenie výparníkov s hnacím plynom	100	305.53.1000	3,50	
Sprej na čistenie výparníkov s hnacím plynom	500	305.53.1010	8,40	
Sprej na čistenie výparníkov do áut BOMBA	100	305.53.1005	3,15	
Roztok na čistenie výparníkov s rozprašovačom	1000	305.53.1015	10,85	
Náhradná náplň na čistenie výparníkov bez rozprašovača	1000	305.53.1035	9,45	
Náhradná náplň na čistenie výparníkov bez rozprašovača, veľké balenie	5000	305.53.1025	49,00	
Roztok na čistenie kondenzátorov s rozprašovačom	1000	305.53.1020	12,25	
Náhradná náplň na čistenie kondenzátorov bez rozprašovača	1000	305.53.1040	10,15	
Sprej na detekciu úniku	500	477.99.1305	5,32	



## Nemrznúce zmesi - GLYKOL

Typ	Náplň [kg]	Bod tuhnutia	DTN obj. číslo	Cena za kg bez DPH
MONOETYLÉN GLYKOL - PRIEMYSELNÝ mono etylén glykol koncentrát 99%	230	v závislosti od pomeru miešania - vid' tabuľka	303.27.1000	3,-
PROPYLÉN GLYKOL - POTRAVINÁRSKY propylén glykol koncentrát 99%	215	v závislosti od pomeru miešania - vid' tabuľka	303.27.1200	4,50

Nádoba s uzáverom 10 L - cena 3,60 Eur bez DPH

Nádoba s uzáverom 50 L - cena 31,20 Eur bez DPH (nádoba sa dobropisuje pri vrátení)

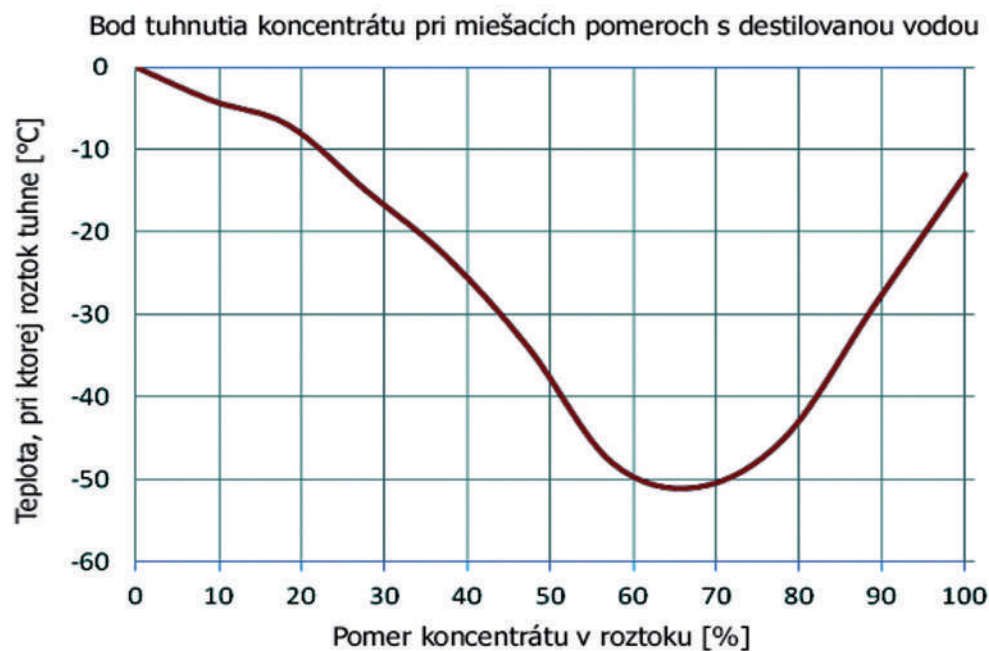

NEMRZNÚCE ZMESI

## Testery kyslosti maziva

Typ	Popis	DTN obj. číslo
Tester kyslosti v ampulke s kvapkadlom	Tester pre syntetické a minerálne mazivá	302.00.8000
OIL-ID (4669890)	Pomocou OIL-ID je možné zistiť typ použitého maziva (syntetické, alebo minerálne)	302.00.8005
ACID-DETECTOR (4669904)	Tester pre minerálne mazivá	302.00.8010
ACID-DETECTOR-POE (4669912)	Tester pre syntetické mazivá	302.00.8015

